

## Rusticated Weatherboard - Standard Profile

Drawing	Sheet Name	Effective Cover	Date	Codemark	Cedar	Truwood	Larch
<b>135x18.5mm Profile Range</b>							
RK67	135x18.5mm Profile	110mm	12.10.2020	Yes	Yes	Yes	No
<b>190x18.5mm Profile Range</b>							
RK68	190x18.5mm Profile	165mm	12.10.2020	Yes	Yes	Yes	No



## Rusticated Weatherboard - Architectural Profiles Codemarked

Drawing	Sheet Name	Effective Cover	Date	Codemark	Cedar	Truwood	Larch
<b>87x28mm Profile Range</b>							
RKA701	87x28mm Profile	56mm	12.10.2020	Yes	Yes	No	No
<b>89x18.5mm Profile Range</b>							
RKA700	89x18.5mm Profile	61mm	12.10.2020	Yes	Yes	Yes	No
<b>137x18.5mm Profile Range</b>							
RKA703	137x28mm Profile	106mm	12.10.2020	Yes	Yes	No	No
<b>139x18.5mm Profile Range</b>							
RKA702	139x18.5mm Profile	111mm	12.10.2020	Yes	Yes	Yes	No
RKA702 PP-U	139x18.5mm Profile Paint Finish	111mm	12.10.2020	Yes	Yes	No	No
<b>140x18.5mm Profile Range</b>							
RKA741	140x18.5mm Profile	111mm	12.10.2020	Yes	Yes	No	No
RKA742	140x18.5mm Profile	112mm	12.10.2020	Yes	Yes	No	No
RKA743	140x18.5mm Profile	115mm	12.10.2020	Yes	Yes	No	No
RKA744	140x18.5mm Profile	115mm	12.10.2020	Yes	Yes	No	No
RKA745	140x18.5mm Profile	111mm	12.10.2020	Yes	Yes	No	No
<b>140x28mm Profile Range</b>							
RKA713	140x28mm Profile	110mm	12.10.2020	Yes	Yes	No	Yes
<b>180x18.5mm Profile Range</b>							
RKA761	180x18.5mm Profile	151mm	12.10.2020	Yes	Yes	No	No
RKA764	180x18.5mm Profile	155mm	12.10.2020	Yes	Yes	No	No
<b>187x28mm Profile Range</b>							
RKA705	187x28mm Profile	156mm	12.10.2020	Yes	Yes	No	No
<b>189x18.5mm Profile Range</b>							
RKA704	189x18.5mm Profile	161mm	12.10.2020	Yes	Yes	Yes	No
<b>190x18.5mm Profile Range</b>							
RKA704 PP-U	189x18.5mm Profile Paint Finish	161mm	12.10.2020	Yes	Yes	No	No
RKA763	190x18.5mm Profile	165mm	12.10.2020	Yes	Yes	No	No
RKA767	190x18.5mm Profile	161mm	12.10.2020	Yes	Yes	No	No
<b>190x28mm Profile Range</b>							
RKA715	190x28mm Profile	160mm	12.10.2020	Yes	Yes	No	Yes



www.rosenfeldkidson.co.nz

Postal address: PO Box 621,  
Shortland Street, Auckland 1140

**Auckland Branch:**  
T: +64 9 573 0503  
F: +64 9 573 0504  
513 Mt Wellington Highway  
Mt Wellington, Auckland 1060

**Christchurch Branch:**  
T: +64 3 349 3316  
F: +64 3 349 3317  
15 Edmonton Road  
Hornby, Christchurch 8042

Title **Profile Index - Codemarked Profiles**

Drawing

**PROFILE CM**

Scale @ A4

Date 12.10.2020

## Rusticated Weatherboard - Random Width Profiles

Drawing	Sheet Name	Effective Cover	Date	Codemark	Cedar	Truwood	Larch
<b>89x18.5mm Profile Range</b>							
RKA700	89x18.5mm Profile	61mm	12.10.2020	Yes	Yes	Yes	No
<b>139x18.5mm Profile Range</b>							
RKA702	139x18.5mm Profile	111mm	12.10.2020	Yes	Yes	Yes	No
<b>189x18.5mm Profile Range</b>							
RKA704	189x18.5mm Profile	161mm	12.10.2020	Yes	Yes	Yes	No



## Rusticated Weatherboard - Random Depth & Width Profiles

Drawing	Sheet Name	Effective Cover	Date	Codemark	Cedar	Truwood	Larch
<b>87x28mm Profile Range</b>							
RKA701	87x28mm Profile	56mm	12.10.2020	Yes	Yes	No	No
<b>89x18.5mm Profile Range</b>							
RKA700	89x18.5mm Profile	61mm	12.10.2020	Yes	Yes	Yes	No
<b>137x18.5mm Profile Range</b>							
RKA703	137x28mm Profile	106mm	12.10.2020	Yes	Yes	No	No
<b>139x18.5mm Profile Range</b>							
RKA702	139x18.5mm Profile	111mm	12.10.2020	Yes	Yes	Yes	No
<b>187x28mm Profile Range</b>							
RKA705	187x28mm Profile	156mm	12.10.2020	Yes	Yes	No	No
<b>189x18.5mm Profile Range</b>							
RKA704	189x18.5mm Profile	161mm	12.10.2020	Yes	Yes	Yes	No



www.rosenfeldkidson.co.nz

Postal address: PO Box 621,  
Shortland Street, Auckland 1140

**Auckland Branch:**  
T: +64 9 573 0503  
F: +64 9 573 0504  
513 Mt Wellington Highway  
Mt Wellington, Auckland 1060

**Christchurch Branch:**  
T: +64 3 349 3316  
F: +64 3 349 3317  
15 Edmonton Road  
Hornby, Christchurch 8042

Title **Profile Index**

Drawing

**PROFILE 3**

Scale @ A4

Date 12.10.2020



1. Profile for oiled or stained weatherboards only.
2. Profiles as per NZS 3617, Branz Bulletin 411 and/or compliance achieved through in-service history, length of service not less than 15 years in all NZ environments B2/VM1 1.1.1 (a).
3. Timber to comply with NZBC B2 Durability B2.3.1 (b).
4. Profiles shall be fixed in accordance with E2/AS1 Table 24.

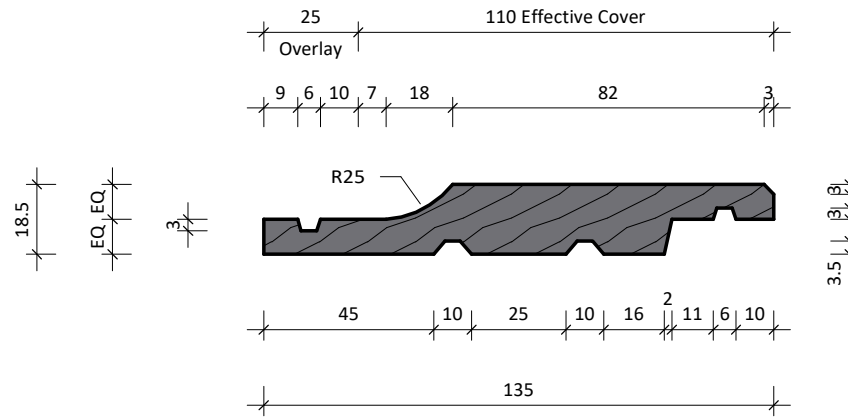
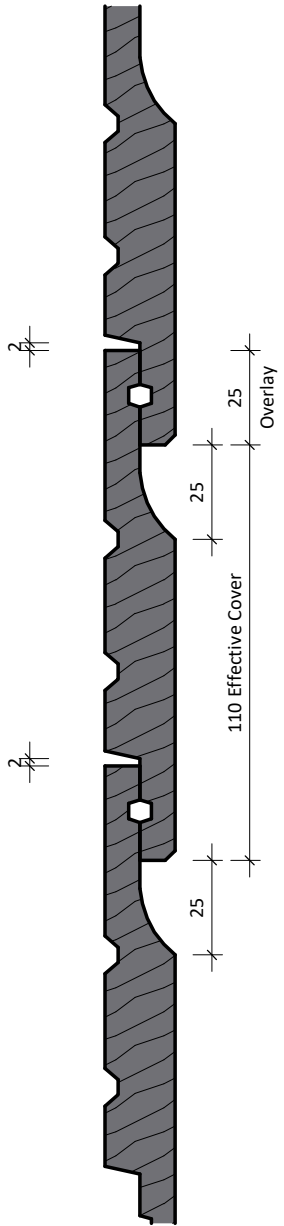

[www.rosenfeldkidson.co.nz](http://www.rosenfeldkidson.co.nz)

Postal address: PO Box 621,  
Shortland Street, Auckland 1140

**Auckland Branch:**

T: +64 9 573 0503  
F: +64 9 573 0504  
513 Mt Wellington Highway  
Mt Wellington, Auckland 1060

**Christchurch Branch:**

T: +64 3 349 3316  
F: +64 3 349 3317  
15 Edmonton Road  
Hornby, Christchurch 8042

Title	<b>135x18.5mm Profile</b>		
Drawing	<b>RK67</b>		
Scale	1 : 2 @ A4	Date	12.10.2020

1. Profile for oiled or stained weatherboards only.
2. Profiles as per NZS 3617, Branz Bulletin 411 and/or compliance achieved through in-service history, length of service not less than 15 years in all NZ environments B2/VM1 1.1.1 (a).
3. Timber to comply with NZBC B2 Durability B2.3.1 (b).
4. Profiles shall be fixed in accordance with E2/AS1 Table 24.

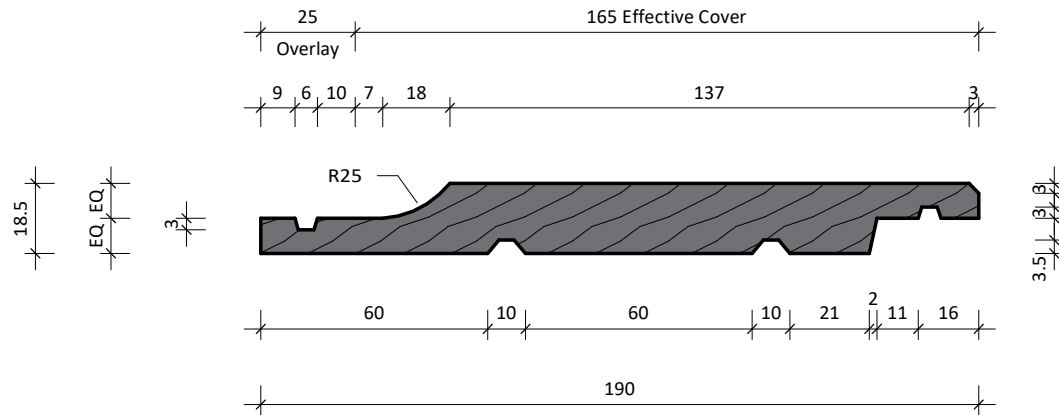
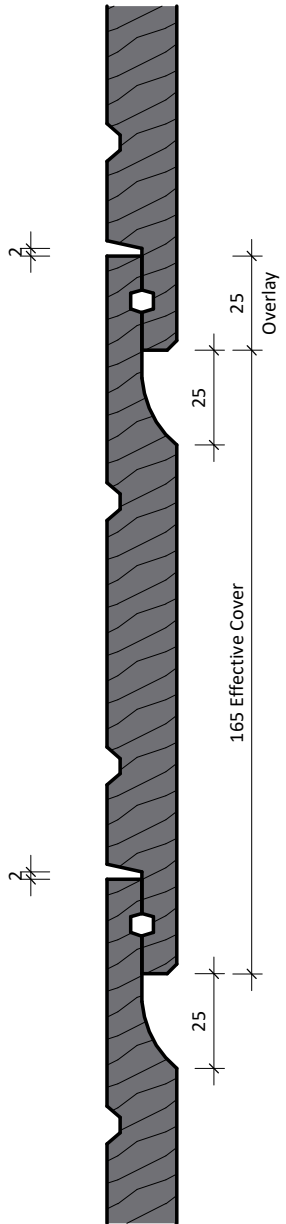

[www.rosenfeldkidson.co.nz](http://www.rosenfeldkidson.co.nz)

Postal address: PO Box 621,  
Shortland Street, Auckland 1140

**Auckland Branch:**

T: +64 9 573 0503  
F: +64 9 573 0504  
513 Mt Wellington Highway  
Mt Wellington, Auckland 1060

**Christchurch Branch:**

T: +64 3 349 3316  
F: +64 3 349 3317  
15 Edmonton Road  
Hornby, Christchurch 8042

Title	190x18.5mm Profile		
Drawing	RK68		
Scale	1 : 2 @ A4	Date	12.10.2020

1. Profile for oiled or stained weatherboards only.
2. Profiles as per NZS 3617, Branz Bulletin 411 and/or compliance achieved through in-service history, length of service not less than 15 years in all NZ environments B2/VM1 1.1.1 (a).
3. Timber to comply with NZBC B2 Durability B2.3.1 (b).
4. Profiles shall be fixed in accordance with E2/AS1 Table 24.

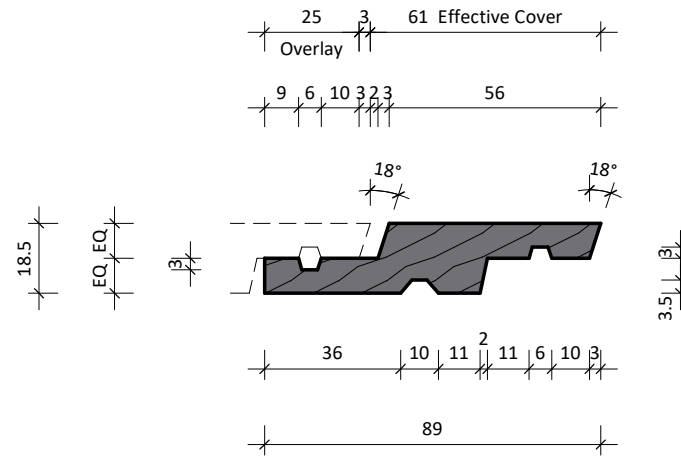
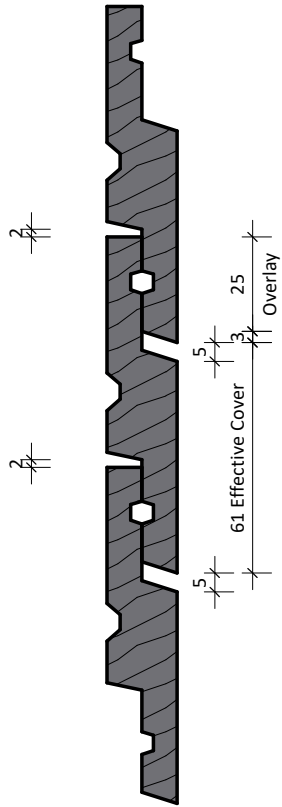

[www.rosenfeldkidson.co.nz](http://www.rosenfeldkidson.co.nz)

Postal address: PO Box 621,  
Shortland Street, Auckland 1140

**Auckland Branch:**

T: +64 9 573 0503  
F: +64 9 573 0504  
513 Mt Wellington Highway  
Mt Wellington, Auckland 1060

**Christchurch Branch:**

T: +64 3 349 3316  
F: +64 3 349 3317  
15 Edmonton Road  
Hornby, Christchurch 8042

Title **89x18.5mm Profile**

Drawing

**RKA700**

Scale 1 : 2 @ A4 Date 12.10.2020

1. Profile for oiled or stained weatherboards only.
2. Profiles as per NZS 3617, Branz Bulletin 411 and/or compliance achieved through in-service history, length of service not less than 15 years in all NZ environments B2/VM1 1.1.1 (a).
3. Timber to comply with NZBC B2 Durability B2.3.1 (b).
4. Profiles shall be fixed in accordance with E2/AS1 Table 24.

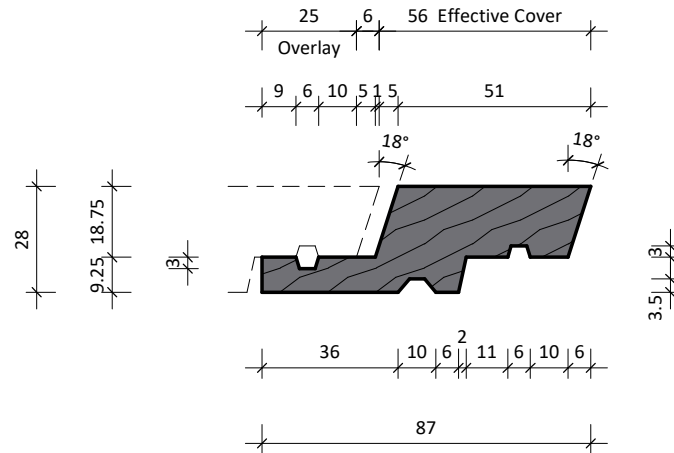
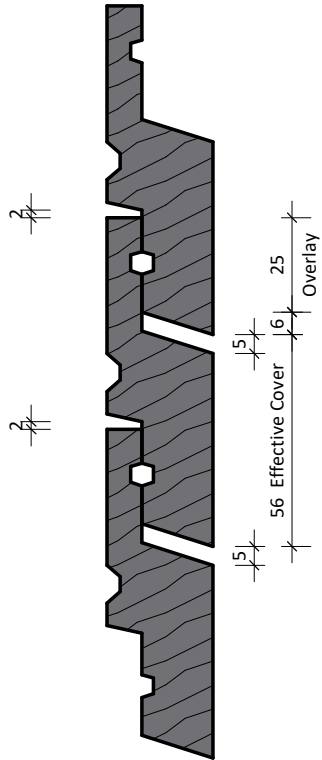

[www.rosenfeldkidson.co.nz](http://www.rosenfeldkidson.co.nz)

Postal address: PO Box 621,  
Shortland Street, Auckland 1140

**Auckland Branch:**

T: +64 9 573 0503  
F: +64 9 573 0504  
513 Mt Wellington Highway  
Mt Wellington, Auckland 1060

**Christchurch Branch:**

T: +64 3 349 3316  
F: +64 3 349 3317  
15 Edmonton Road  
Hornby, Christchurch 8042

Title **87x28mm Profile**

Drawing **RKA701**

Scale 1 : 2 @ A4 Date 12.10.2020

1. Profile for oiled or stained weatherboards only.
2. Profiles as per NZS 3617, Branz Bulletin 411 and/or compliance achieved through in-service history, length of service not less than 15 years in all NZ environments B2/VM1 1.1.1 (a).
3. Timber to comply with NZBC B2 Durability B2.3.1 (b).
4. Profiles shall be fixed in accordance with E2/AS1 Table 24.

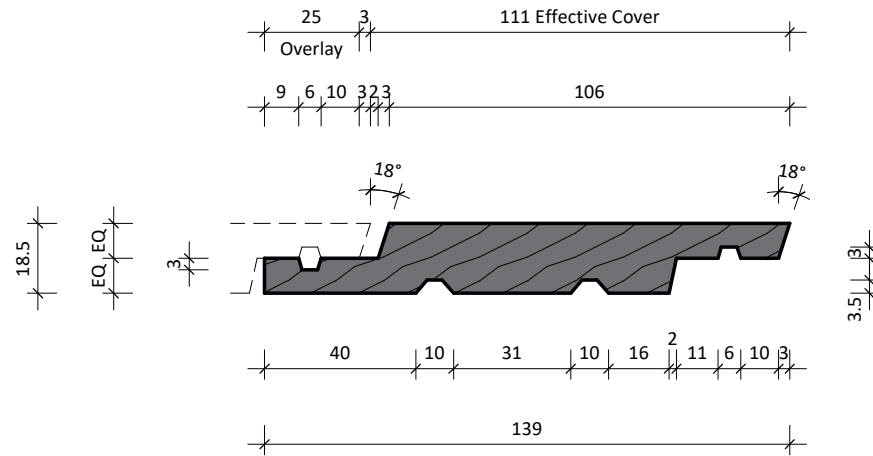
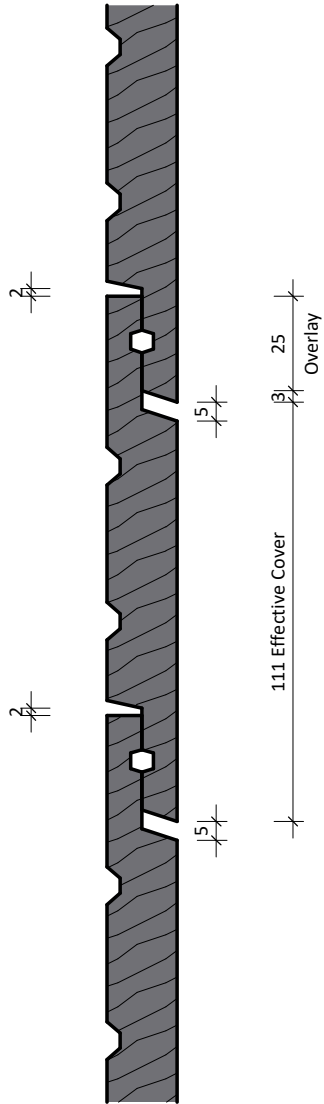

www.rosenfeldkidson.co.nz

Postal address: PO Box 621,  
Shortland Street, Auckland 1140

**Auckland Branch:**

T: +64 9 573 0503  
F: +64 9 573 0504  
513 Mt Wellington Highway  
Mt Wellington, Auckland 1060

**Christchurch Branch:**

T: +64 3 349 3316  
F: +64 3 349 3317  
15 Edmonton Road  
Hornby, Christchurch 8042

Title	<b>139x18.5mm Profile</b>		
Drawing	<b>RKA702</b>		
Scale	1 : 2 @ A4	Date	12.10.2020





1. Profile for paint finish weatherboards only.
2. Profiles as per NZS 3617, Branz Bulletin 411 and/or compliance achieved through in-service history, length of service not less than 15 years in all NZ environments B2/VM1 1.1.1 (a).
3. Timber to comply with NZBC B2 Durability B2.3.1 (b).
4. Profiles shall be fixed in accordance with E2/AS1 Table 24.

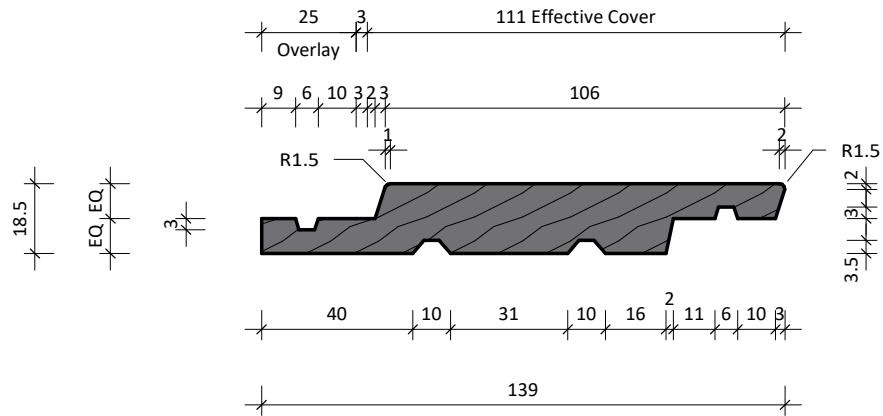
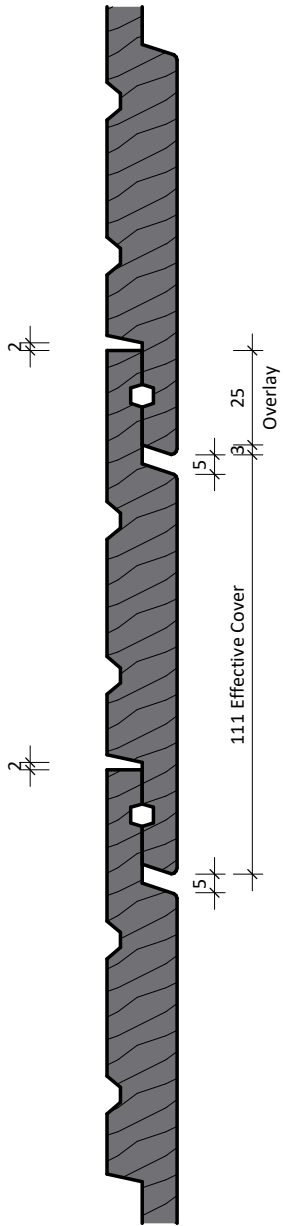

[www.rosenfeldkidson.co.nz](http://www.rosenfeldkidson.co.nz)

Postal address: PO Box 621,  
Shortland Street, Auckland 1140

**Auckland Branch:**

T: +64 9 573 0503  
F: +64 9 573 0504  
513 Mt Wellington Highway  
Mt Wellington, Auckland 1060

**Christchurch Branch:**

T: +64 3 349 3316  
F: +64 3 349 3317  
15 Edmonton Road  
Hornby, Christchurch 8042

Title **139x18.5mm Profile Paint Finish**

Drawing **RKA702 PP-U**

Scale 1 : 2 @ A4 Date 12.10.2020

1. Profile for oiled or stained weatherboards only.
2. Profiles as per NZS 3617, Branz Bulletin 411 and/or compliance achieved through in-service history, length of service not less than 15 years in all NZ environments B2/VM1 1.1.1 (a).
3. Timber to comply with NZBC B2 Durability B2.3.1 (b).
4. Profiles shall be fixed in accordance with E2/AS1 Table 24.

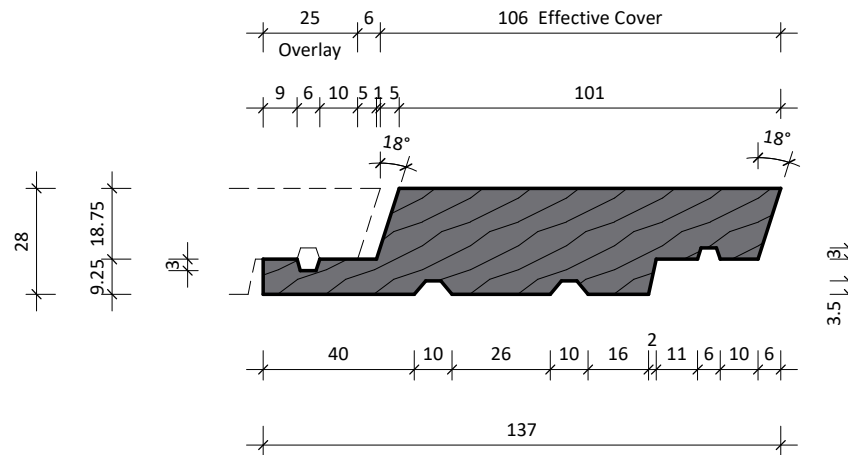
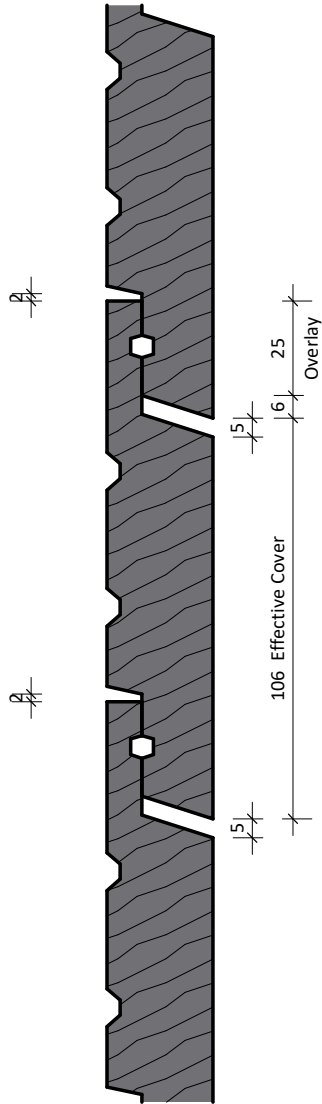

[www.rosenfeldkidson.co.nz](http://www.rosenfeldkidson.co.nz)

Postal address: PO Box 621,  
Shortland Street, Auckland 1140

**Auckland Branch:**

T: +64 9 573 0503  
F: +64 9 573 0504  
513 Mt Wellington Highway  
Mt Wellington, Auckland 1060

**Christchurch Branch:**

T: +64 3 349 3316  
F: +64 3 349 3317  
15 Edmonton Road  
Hornby, Christchurch 8042

Title **137x28mm Profile**

Drawing **RKA703**

Scale 1 : 2 @ A4 Date 12.10.2020

1. Profile for oiled or stained weatherboards only.
2. Profiles as per NZS 3617, Branz Bulletin 411 and/or compliance achieved through in-service history, length of service not less than 15 years in all NZ environments B2/VM1 1.1.1 (a).
3. Timber to comply with NZBC B2 Durability B2.3.1 (b).
4. Profiles shall be fixed in accordance with E2/AS1 Table 24.

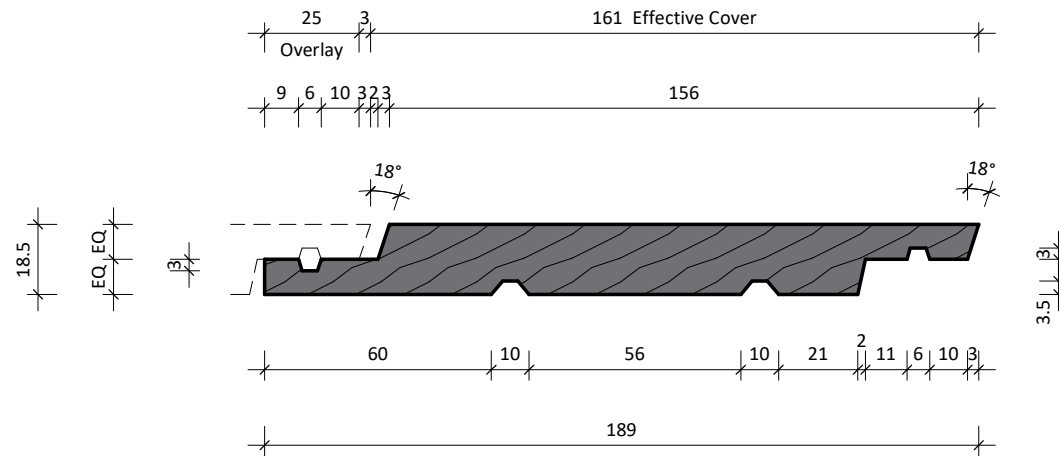
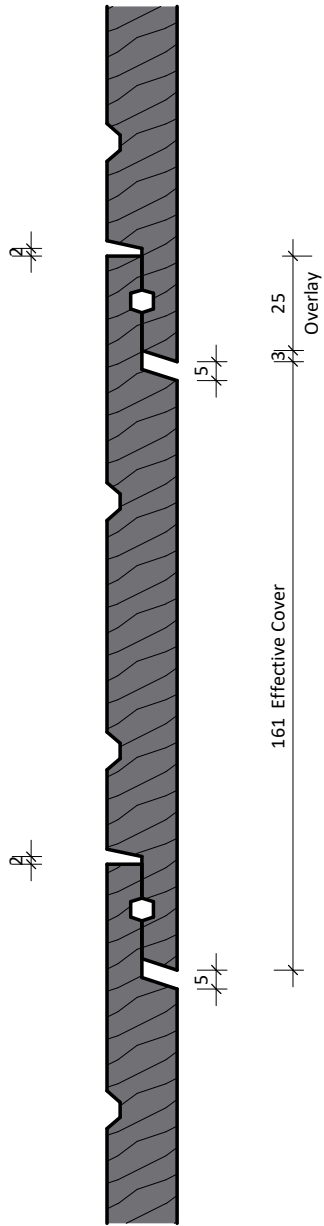

[www.rosenfeldkidson.co.nz](http://www.rosenfeldkidson.co.nz)

Postal address: PO Box 621,  
Shortland Street, Auckland 1140

**Auckland Branch:**

T: +64 9 573 0503  
F: +64 9 573 0504  
513 Mt Wellington Highway  
Mt Wellington, Auckland 1060

**Christchurch Branch:**

T: +64 3 349 3316  
F: +64 3 349 3317  
15 Edmonton Road  
Hornby, Christchurch 8042

Title	189x18.5mm Profile		
Drawing	RKA704		
Scale	1 : 2 @ A4	Date	12.10.2020

1. Profile for paint finish weatherboards only.
2. Profiles as per NZS 3617, Branz Bulletin 411 and/or compliance achieved through in-service history, length of service not less than 15 years in all NZ environments B2/VM1 1.1.1 (a).
3. Timber to comply with NZBC B2 Durability B2.3.1 (b).
4. Profiles shall be fixed in accordance with E2/AS1 Table 24.

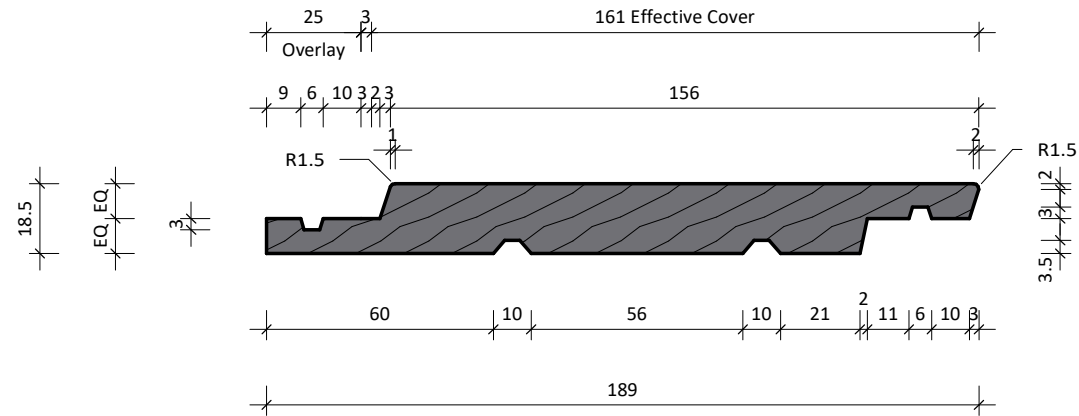
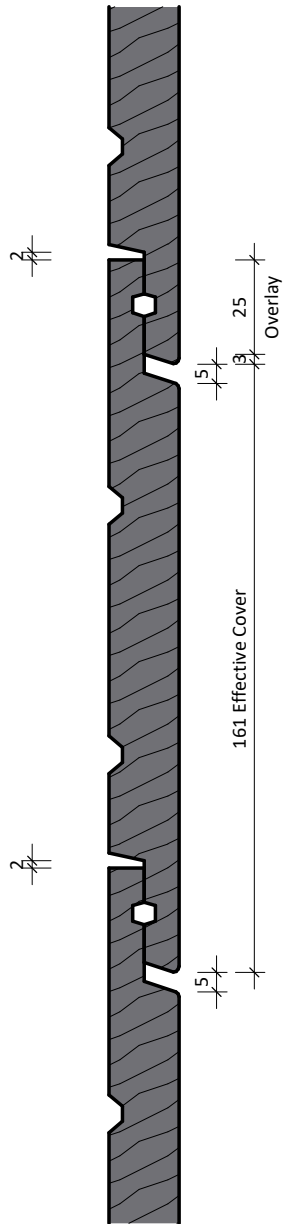

[www.rosenfeldkidson.co.nz](http://www.rosenfeldkidson.co.nz)

Postal address: PO Box 621,  
Shortland Street, Auckland 1140

**Auckland Branch:**

T: +64 9 573 0503

F: +64 9 573 0504

513 Mt Wellington Highway

Mt Wellington, Auckland 1060

**Christchurch Branch:**

T: +64 3 349 3316

F: +64 3 349 3317

15 Edmonton Road

Hornby, Christchurch 8042

Title **189x18.5mm Profile Paint Finish**

Drawing

**RKA704 PP-U**

Scale 1 : 2 @ A4

Date 12.10.2020

1. Profile for oiled or stained weatherboards only.
2. Profiles as per NZS 3617, Branz Bulletin 411 and/or compliance achieved through in-service history, length of service not less than 15 years in all NZ environments B2/VM1 1.1.1 (a).
3. Timber to comply with NZBC B2 Durability B2.3.1 (b).
4. Profiles shall be fixed in accordance with E2/AS1 Table 24.

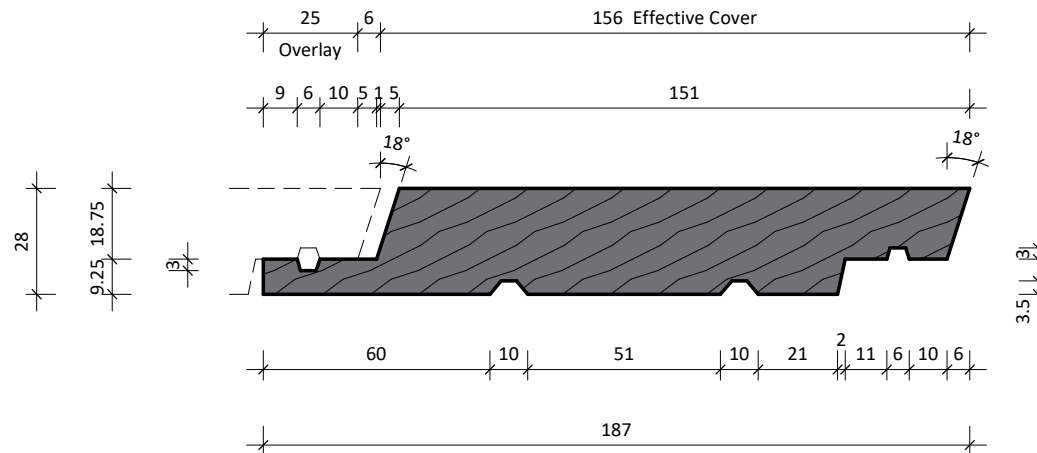
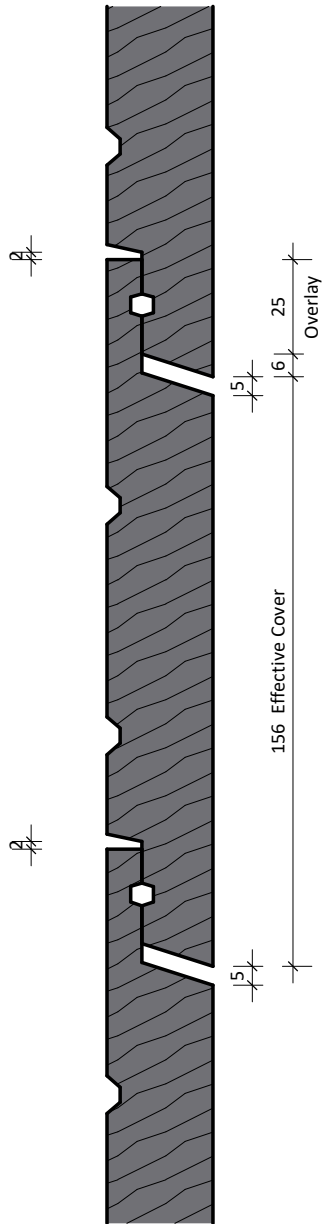

[www.rosenfeldkidson.co.nz](http://www.rosenfeldkidson.co.nz)

Postal address: PO Box 621,  
Shortland Street, Auckland 1140

**Auckland Branch:**

T: +64 9 573 0503  
F: +64 9 573 0504  
513 Mt Wellington Highway  
Mt Wellington, Auckland 1060

**Christchurch Branch:**

T: +64 3 349 3316  
F: +64 3 349 3317  
15 Edmonton Road  
Hornby, Christchurch 8042

Title **187x28mm Profile**

Drawing **RKA705**

Scale 1 : 2 @ A4 Date 12.10.2020

1. Profile for oiled or stained weatherboards only.
2. Profiles as per NZS 3617, Branz Bulletin 411 and/or compliance achieved through in-service history, length of service not less than 15 years in all NZ environments B2/VM1 1.1.1 (a).
3. Timber to comply with NZBC B2 Durability B2.3.1 (b).
4. Profiles shall be fixed in accordance with E2/AS1 Table 24.

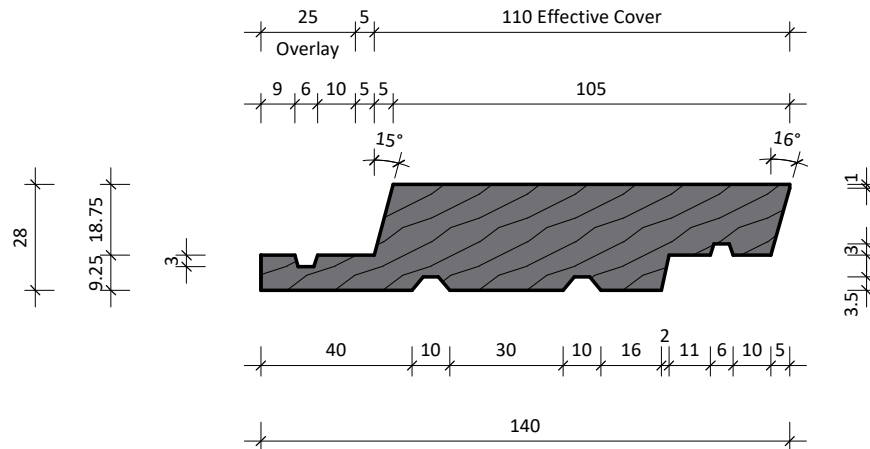
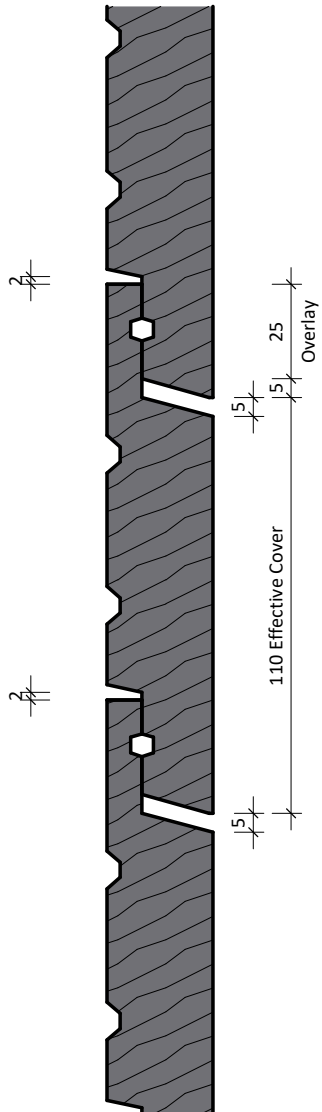

www.rosenfeldkidson.co.nz

Postal address: PO Box 621,  
Shortland Street, Auckland 1140

**Auckland Branch:**

T: +64 9 573 0503  
F: +64 9 573 0504  
513 Mt Wellington Highway  
Mt Wellington, Auckland 1060

**Christchurch Branch:**

T: +64 3 349 3316  
F: +64 3 349 3317  
15 Edmonton Road  
Hornby, Christchurch 8042

Title **140x28mm Profile**

Drawing **RKA713**

Scale 1 : 2 @ A4 Date 12.10.2020

1. Profile for oiled or stained weatherboards only.
2. Profiles as per NZS 3617, Branz Bulletin 411 and/or compliance achieved through in-service history, length of service not less than 15 years in all NZ environments B2/VM1 1.1.1 (a).
3. Timber to comply with NZBC B2 Durability B2.3.1 (b).
4. Profiles shall be fixed in accordance with E2/AS1 Table 24.

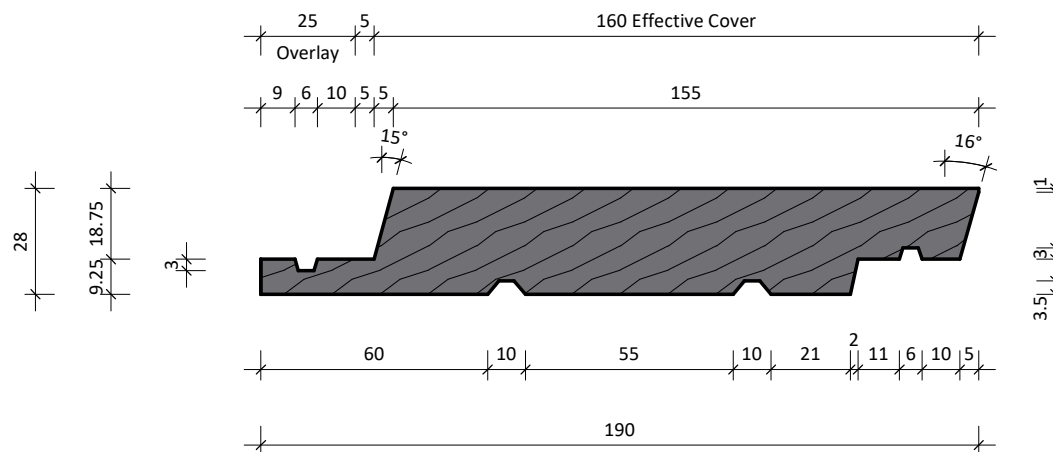
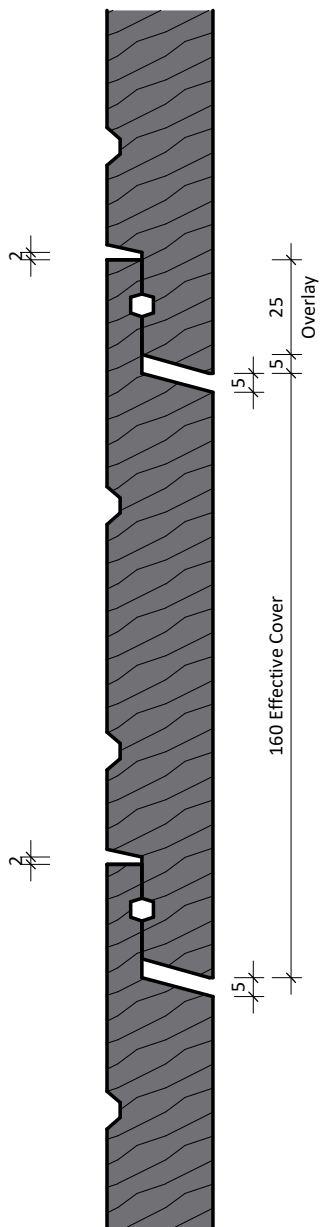

[www.rosenfeldkidson.co.nz](http://www.rosenfeldkidson.co.nz)

Postal address: PO Box 621,  
Shortland Street, Auckland 1140

**Auckland Branch:**

T: +64 9 573 0503  
F: +64 9 573 0504  
513 Mt Wellington Highway  
Mt Wellington, Auckland 1060

**Christchurch Branch:**

T: +64 3 349 3316  
F: +64 3 349 3317  
15 Edmonton Road  
Hornby, Christchurch 8042

Title **190x28mm Profile**

Drawing **RKA715**

Scale 1 : 2 @ A4 Date 12.10.2020

1. Profile for oiled or stained weatherboards only.
2. Profiles as per NZS 3617, Branz Bulletin 411 and/or compliance achieved through in-service history, length of service not less than 15 years in all NZ environments B2/VM1 1.1.1 (a).
3. Timber to comply with NZBC B2 Durability B2.3.1 (b).
4. Profiles shall be fixed in accordance with E2/AS1 Table 24.

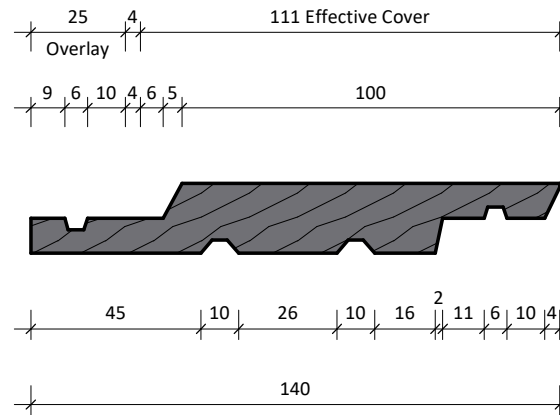
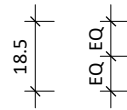
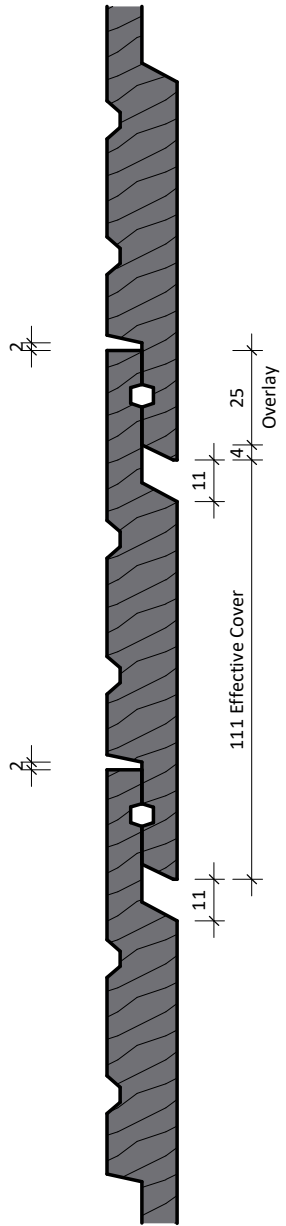

[www.rosenfeldkidson.co.nz](http://www.rosenfeldkidson.co.nz)

Postal address: PO Box 621,  
Shortland Street, Auckland 1140

**Auckland Branch:**

T: +64 9 573 0503  
F: +64 9 573 0504  
513 Mt Wellington Highway  
Mt Wellington, Auckland 1060

**Christchurch Branch:**

T: +64 3 349 3316  
F: +64 3 349 3317  
15 Edmonton Road  
Hornby, Christchurch 8042

Title **140x18.5mm Profile**

Drawing **RKA741**

Scale 1 : 2 @ A4 Date 12.10.2020



1. Profile for oiled or stained weatherboards only.
2. Profiles as per NZS 3617, Branz Bulletin 411 and/or compliance achieved through in-service history, length of service not less than 15 years in all NZ environments B2/VM1 1.1.1 (a).
3. Timber to comply with NZBC B2 Durability B2.3.1 (b).
4. Profiles shall be fixed in accordance with E2/AS1 Table 24.

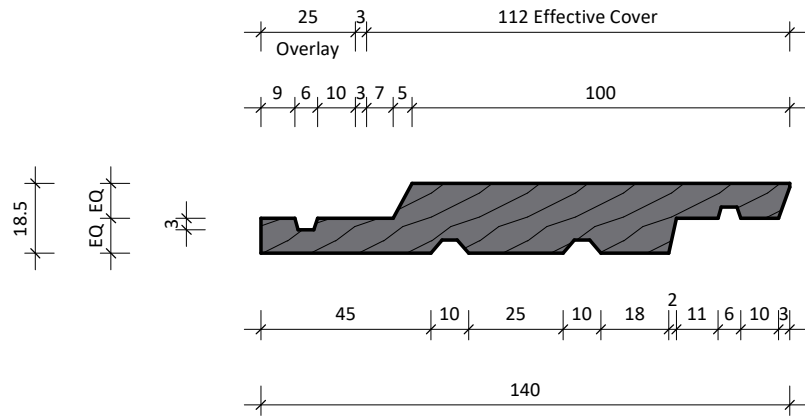
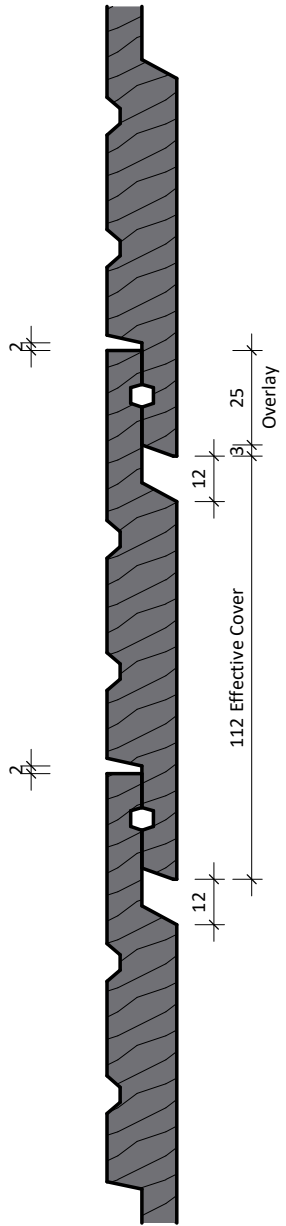

[www.rosenfeldkidson.co.nz](http://www.rosenfeldkidson.co.nz)

Postal address: PO Box 621,  
Shortland Street, Auckland 1140

**Auckland Branch:**

T: +64 9 573 0503  
F: +64 9 573 0504  
513 Mt Wellington Highway  
Mt Wellington, Auckland 1060

**Christchurch Branch:**

T: +64 3 349 3316  
F: +64 3 349 3317  
15 Edmonton Road  
Hornby, Christchurch 8042

Title **140x18.5mm Profile**

Drawing **RKA742**

Scale 1 : 2 @ A4 Date 12.10.2020

1. Profile for oiled or stained weatherboards only.
2. Profiles as per NZS 3617, Branz Bulletin 411 and/or compliance achieved through in-service history, length of service not less than 15 years in all NZ environments B2/VM1 1.1.1 (a).
3. Timber to comply with NZBC B2 Durability B2.3.1 (b).
4. Profiles shall be fixed in accordance with E2/AS1 Table 24.

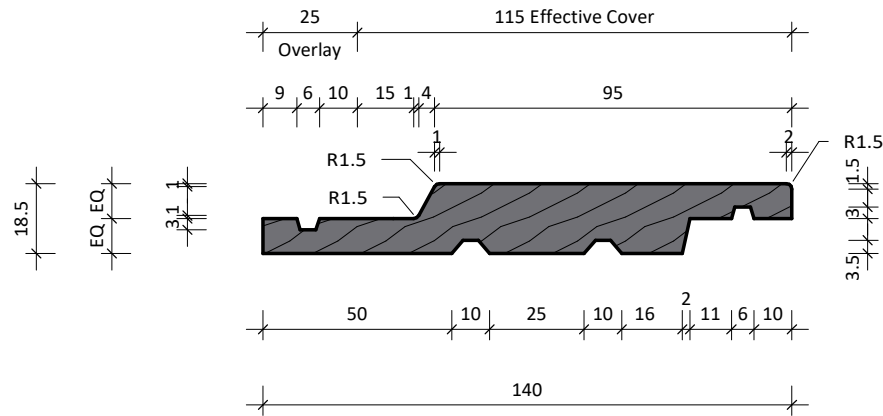
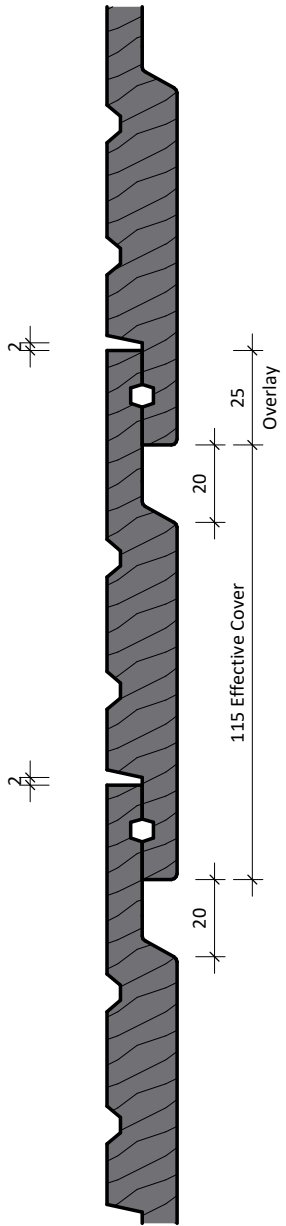

[www.rosenfeldkidson.co.nz](http://www.rosenfeldkidson.co.nz)

Postal address: PO Box 621,  
Shortland Street, Auckland 1140

**Auckland Branch:**

T: +64 9 573 0503  
F: +64 9 573 0504  
513 Mt Wellington Highway  
Mt Wellington, Auckland 1060

**Christchurch Branch:**

T: +64 3 349 3316  
F: +64 3 349 3317  
15 Edmonton Road  
Hornby, Christchurch 8042

Title **140x18.5mm Profile**

Drawing **RKA743**

Scale 1 : 2 @ A4 Date 12.10.2020

1. Profile for oiled or stained weatherboards only.
2. Profiles as per NZS 3617, Branz Bulletin 411 and/or compliance achieved through in-service history, length of service not less than 15 years in all NZ environments B2/VM1 1.1.1 (a).
3. Timber to comply with NZBC B2 Durability B2.3.1 (b).
4. Profiles shall be fixed in accordance with E2/AS1 Table 24.

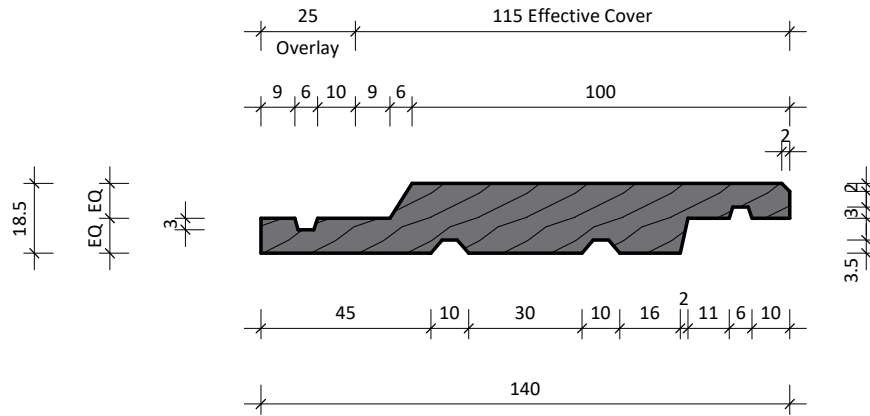
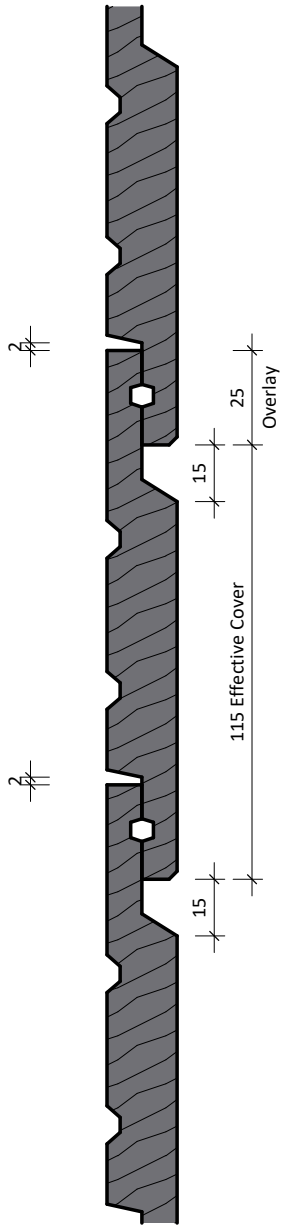

[www.rosenfeldkidson.co.nz](http://www.rosenfeldkidson.co.nz)

Postal address: PO Box 621,  
Shortland Street, Auckland 1140

**Auckland Branch:**

T: +64 9 573 0503  
F: +64 9 573 0504  
513 Mt Wellington Highway  
Mt Wellington, Auckland 1060

**Christchurch Branch:**

T: +64 3 349 3316  
F: +64 3 349 3317  
15 Edmonton Road  
Hornby, Christchurch 8042

Title **140x18.5mm Profile**

Drawing

**RKA744**

Scale 1 : 2 @ A4 Date 12.10.2020

1. Profile for oiled or stained weatherboards only.
2. Profiles as per NZS 3617, Branz Bulletin 411 and/or compliance achieved through in-service history, length of service not less than 15 years in all NZ environments B2/VM1 1.1.1 (a).
3. Timber to comply with NZBC B2 Durability B2.3.1 (b).
4. Profiles shall be fixed in accordance with E2/AS1 Table 24.

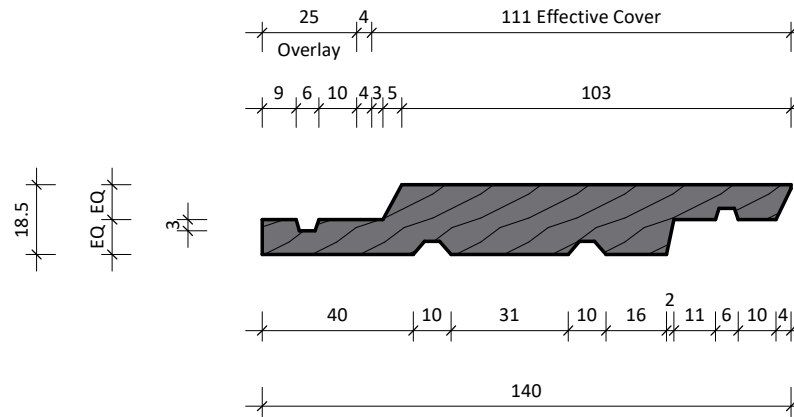
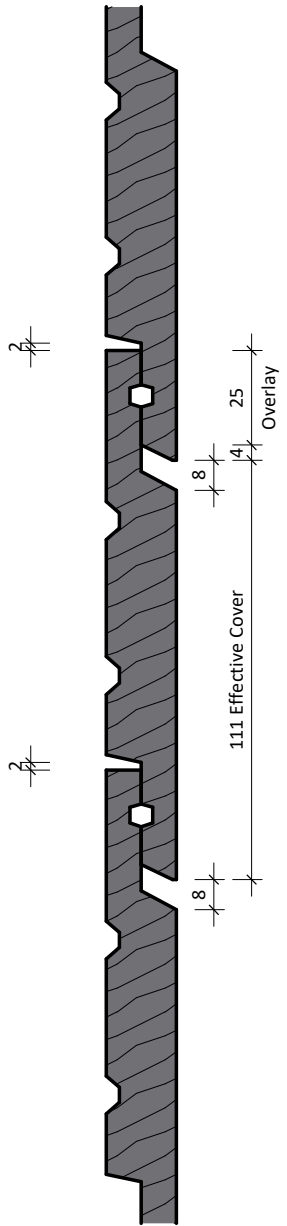

[www.rosenfeldkidson.co.nz](http://www.rosenfeldkidson.co.nz)

Postal address: PO Box 621,  
Shortland Street, Auckland 1140

**Auckland Branch:**

T: +64 9 573 0503  
F: +64 9 573 0504  
513 Mt Wellington Highway  
Mt Wellington, Auckland 1060

**Christchurch Branch:**

T: +64 3 349 3316  
F: +64 3 349 3317  
15 Edmonton Road  
Hornby, Christchurch 8042

Title **140x18.5mm Profile**

Drawing **RKA745**

Scale 1 : 2 @ A4 Date 12.10.2020

1. Profile for oiled or stained weatherboards only.
2. Profiles as per NZS 3617, Branz Bulletin 411 and/or compliance achieved through in-service history, length of service not less than 15 years in all NZ environments B2/VM1 1.1.1 (a).
3. Timber to comply with NZBC B2 Durability B2.3.1 (b).
4. Profiles shall be fixed in accordance with E2/AS1 Table 24.

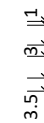
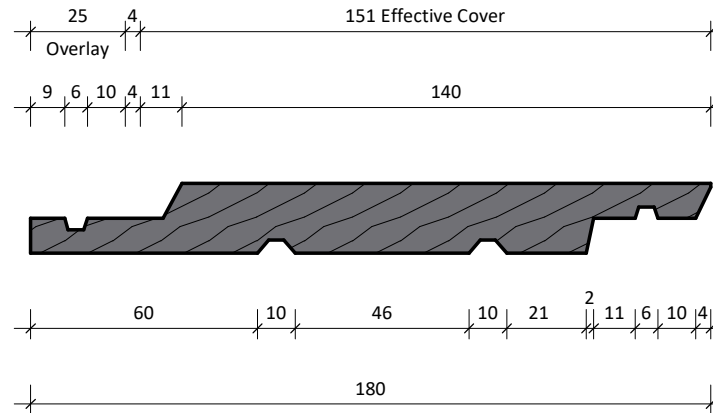
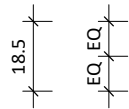
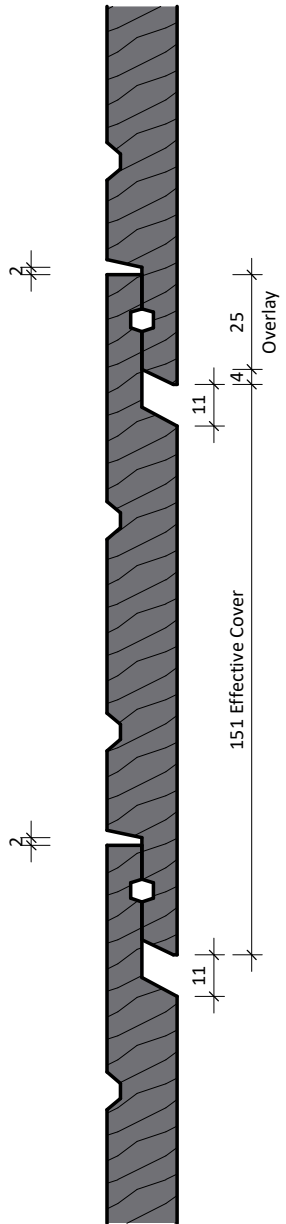

[www.rosenfeldkidson.co.nz](http://www.rosenfeldkidson.co.nz)

Postal address: PO Box 621,  
Shortland Street, Auckland 1140

**Auckland Branch:**

T: +64 9 573 0503  
F: +64 9 573 0504  
513 Mt Wellington Highway  
Mt Wellington, Auckland 1060

**Christchurch Branch:**

T: +64 3 349 3316  
F: +64 3 349 3317  
15 Edmonton Road  
Hornby, Christchurch 8042

Title **180x18.5mm Profile**

Drawing **RKA761**

Scale 1 : 2 @ A4 Date 12.10.2020

1. Profile for oiled or stained weatherboards only.
2. Profiles as per NZS 3617, Branz Bulletin 411 and/or compliance achieved through in-service history, length of service not less than 15 years in all NZ environments B2/VM1 1.1.1 (a).
3. Timber to comply with NZBC B2 Durability B2.3.1 (b).
4. Profiles shall be fixed in accordance with E2/AS1 Table 24.

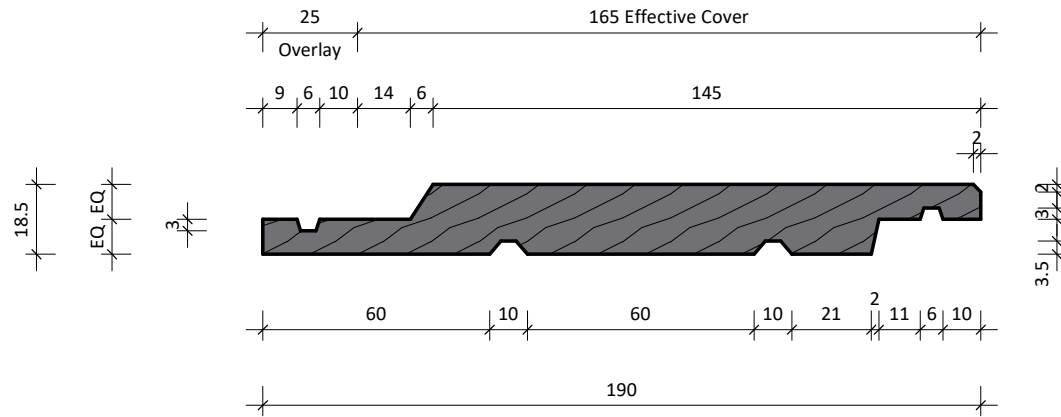
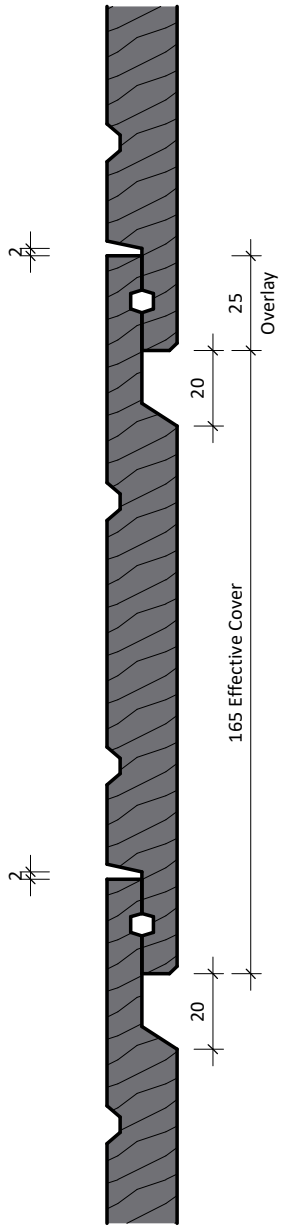

[www.rosenfeldkidson.co.nz](http://www.rosenfeldkidson.co.nz)

Postal address: PO Box 621,  
Shortland Street, Auckland 1140

**Auckland Branch:**

T: +64 9 573 0503  
F: +64 9 573 0504  
513 Mt Wellington Highway  
Mt Wellington, Auckland 1060

**Christchurch Branch:**

T: +64 3 349 3316  
F: +64 3 349 3317  
15 Edmonton Road  
Hornby, Christchurch 8042

Title **190x18.5mm Profile**

Drawing **RKA763**

Scale 1 : 2 @ A4 Date 12.10.2020

1. Profile for oiled or stained weatherboards only.
2. Profiles as per NZS 3617, Branz Bulletin 411 and/or compliance achieved through in-service history, length of service not less than 15 years in all NZ environments B2/VM1 1.1.1 (a).
3. Timber to comply with NZBC B2 Durability B2.3.1 (b).
4. Profiles shall be fixed in accordance with E2/AS1 Table 24.

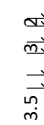
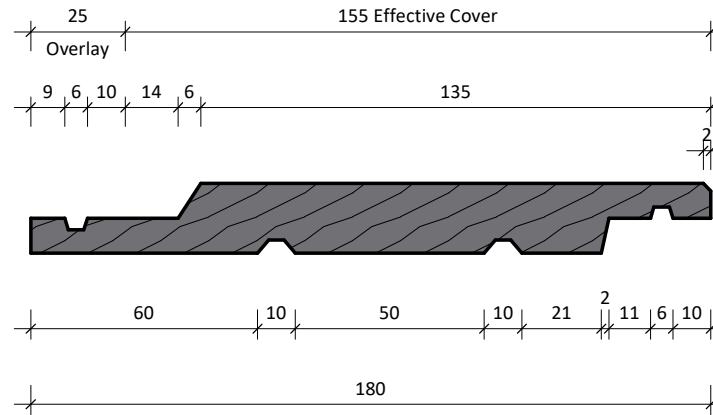
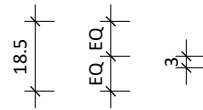
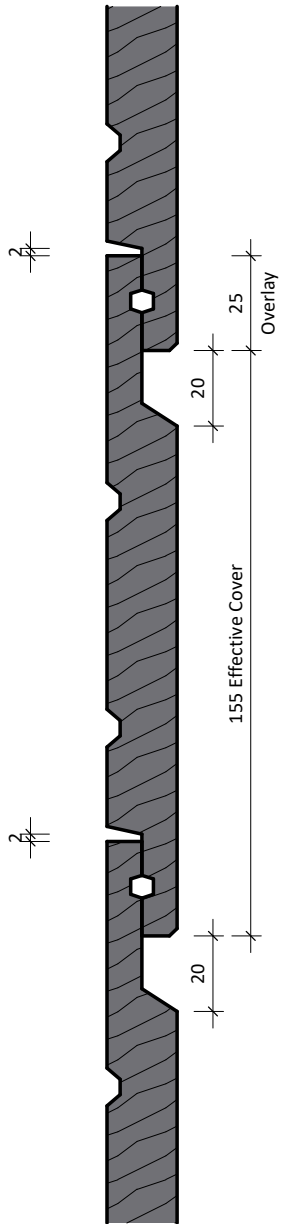

[www.rosenfeldkidson.co.nz](http://www.rosenfeldkidson.co.nz)

Postal address: PO Box 621,  
Shortland Street, Auckland 1140

**Auckland Branch:**

T: +64 9 573 0503  
F: +64 9 573 0504  
513 Mt Wellington Highway  
Mt Wellington, Auckland 1060

**Christchurch Branch:**

T: +64 3 349 3316  
F: +64 3 349 3317  
15 Edmonton Road  
Hornby, Christchurch 8042

Title **180x18.5mm Profile**

Drawing **RKA764**

Scale 1 : 2 @ A4 Date 12.10.2020

1. Profile for oiled or stained weatherboards only.
2. Profiles as per NZS 3617, Branz Bulletin 411 and/or compliance achieved through in-service history, length of service not less than 15 years in all NZ environments B2/VM1 1.1.1 (a).
3. Timber to comply with NZBC B2 Durability B2.3.1 (b).
4. Profiles shall be fixed in accordance with E2/AS1 Table 24.

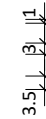
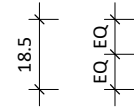
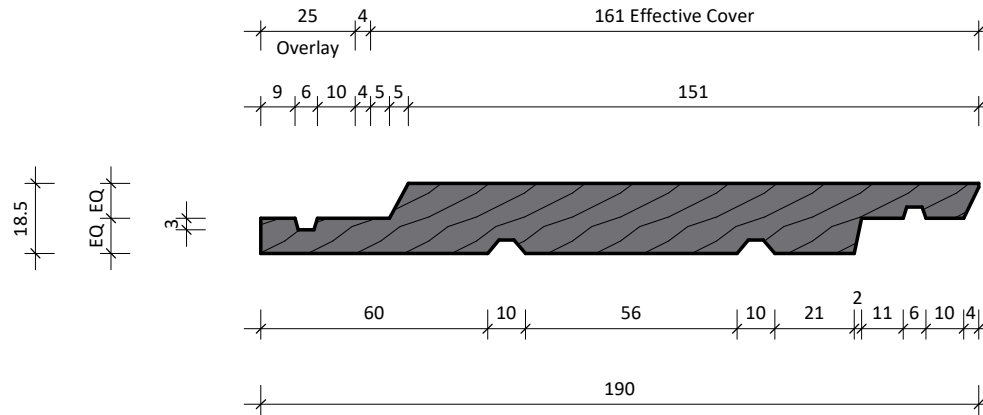
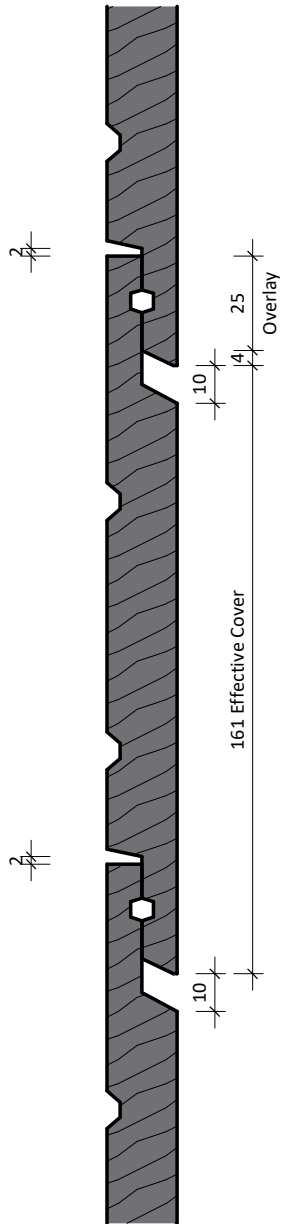

[www.rosenfeldkidson.co.nz](http://www.rosenfeldkidson.co.nz)

Postal address: PO Box 621,  
Shortland Street, Auckland 1140

**Auckland Branch:**

T: +64 9 573 0503  
F: +64 9 573 0504  
513 Mt Wellington Highway  
Mt Wellington, Auckland 1060

**Christchurch Branch:**

T: +64 3 349 3316  
F: +64 3 349 3317  
15 Edmonton Road  
Hornby, Christchurch 8042

Title **190x18.5mm Profile**

Drawing **RKA767**

Scale 1 : 2 @ A4 Date 12.10.2020