



Board & Batten Weatherboard Profiles Codemarked

Drawing	Sheet Name	Effective Cover	Date	Codemark	Cedar	Truwood	Larch
Profiles							
RK120	140x18.5mm Profile	82mm	20.11.2020	Yes	Yes	Yes	Yes
RK120(135mm)	135x18.5mm Profile	77mm	20.11.2020	Yes	Yes	Yes	Yes
RK121	180x18.5mm Profile	122mm	20.11.2020	Yes	Yes	Yes	Yes
RK123	65x18.5mm Profile	65mm	20.11.2020	Yes	Yes	Yes	Yes
Layouts							
RK120-RK123	140x18.5mm & 65x18.5mm Profile		20.11.2020	Yes	Yes	Yes	Yes



www.rosenfeldkidson.co.nz

Postal address: PO Box 621,
Shortland Street, Auckland 1140

Auckland Branch:

T: +64 9 573 0503
F: +64 9 573 0504
513 Mt Wellington Highway
Mt Wellington, Auckland 1060

Christchurch Branch:

T: +64 3 349 3316
F: +64 3 349 3317
15 Edmonton Road
Hornby, Christchurch 8042

Title **Profile Index - Codemarked Profiles**

Drawing **PROFILE CM**

Scale @ A4 Date 20.11.2020

1. Profile for oiled or stained weatherboards only.
2. Profiles as per NZS 3617, Branz Bulletin 411 and/or compliance achieved through in-service history, length of service not less than 15 years in all NZ environments B2/VM1 1.1.1 (a).
3. Timber to comply with NZBC B2 Durability B2.3.1 (b).
4. Profiles shall be fixed in accordance with E2/AS1 Table 24.

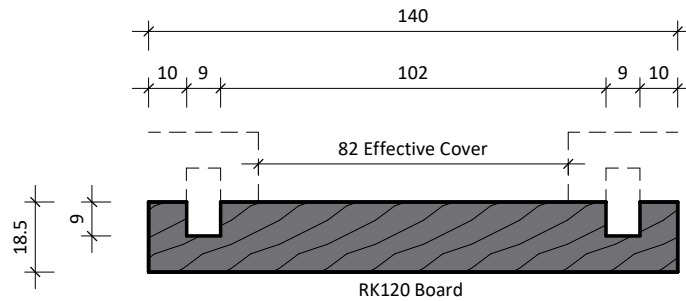

Finish:
- BSF (Band sawn finish)
- DFS (Dressed face sanded)



www.rosenfeldkidson.co.nz

Postal address: PO Box 621,
Shortland Street, Auckland 1140

Auckland Branch:

T: +64 9 573 0503
F: +64 9 573 0504
513 Mt Wellington Highway
Mt Wellington, Auckland 1060

Christchurch Branch:

T: +64 3 349 3316
F: +64 3 349 3317
15 Edmonton Road
Hornby, Christchurch 8042

Title **140x18.5mm Profile**

Drawing

RK120

Scale 1 : 2 @ A4 Date 20.11.2020

1. Profile for oiled or stained weatherboards only.
2. Profiles as per NZS 3617, Branz Bulletin 411 and/or compliance achieved through in-service history, length of service not less than 15 years in all NZ environments B2/VM1 1.1.1 (a).
3. Timber to comply with NZBC B2 Durability B2.3.1 (b).
4. Profiles shall be fixed in accordance with E2/AS1 Table 24.

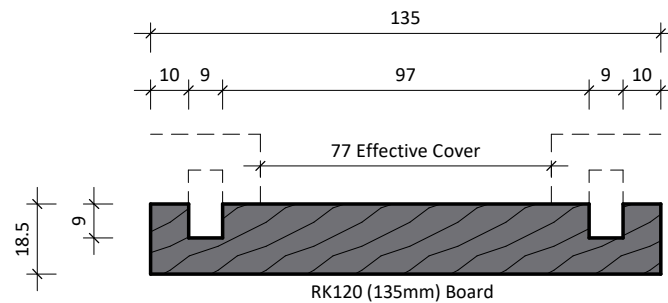

Finish:
 - BSF (Band sawn finish)
 - DFS (Dressed face sanded)



www.rosenfeldkidson.co.nz

Postal address: PO Box 621,
 Shortland Street, Auckland 1140

Auckland Branch:

T: +64 9 573 0503
 F: +64 9 573 0504
 513 Mt Wellington Highway
 Mt Wellington, Auckland 1060

Christchurch Branch:

T: +64 3 349 3316
 F: +64 3 349 3317
 15 Edmonton Road
 Hornby, Christchurch 8042

Title **135x18.5mm Profile**

Drawing **RK120(135mm)**

Scale 1 : 2 @ A4 Date 20.11.2020

1. Profile for oiled or stained weatherboards only.
2. Profiles as per NZS 3617, Branz Bulletin 411 and/or compliance achieved through in-service history, length of service not less than 15 years in all NZ environments B2/VM1 1.1.1 (a).
3. Timber to comply with NZBC B2 Durability B2.3.1 (b).
4. Profiles shall be fixed in accordance with E2/AS1 Table 24.

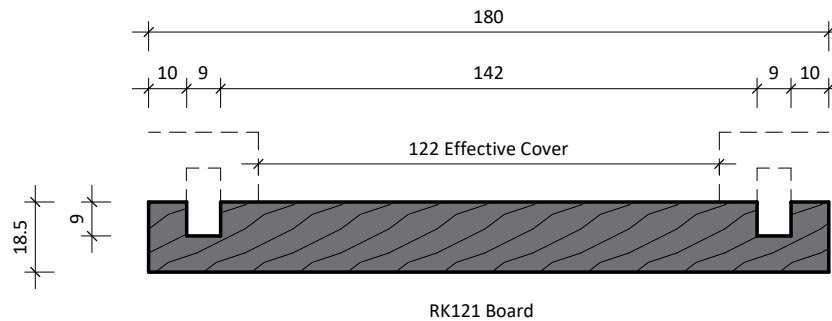

Finish:
 - BSF (Band sawn finish)
 - DFS (Dressed face sanded)



www.rosenfeldkidson.co.nz

Postal address: PO Box 621,
 Shortland Street, Auckland 1140

Auckland Branch:

T: +64 9 573 0503
 F: +64 9 573 0504
 513 Mt Wellington Highway
 Mt Wellington, Auckland 1060

Christchurch Branch:

T: +64 3 349 3316
 F: +64 3 349 3317
 15 Edmonton Road
 Hornby, Christchurch 8042

Title **180x18.5mm Profile**

Drawing **RK121**

Scale 1 : 2 @ A4 Date 20.11.2020

1. Profile for oiled or stained weatherboards only.
2. Profiles as per NZS 3617, Branz Bulletin 411 and/or compliance achieved through in-service history, length of service not less than 15 years in all NZ environments B2/VM1 1.1.1 (a).
3. Timber to comply with NZBC B2 Durability B2.3.1 (b).
4. Profiles shall be fixed in accordance with E2/AS1 Table 24.

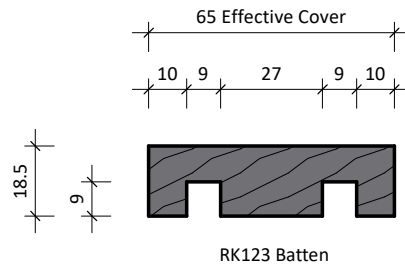

Finish:
 - BSF (Band sawn finish)
 - DFS (Dressed face sanded)



www.rosenfeldkidson.co.nz

Postal address: PO Box 621,
 Shortland Street, Auckland 1140

Auckland Branch:

T: +64 9 573 0503
 F: +64 9 573 0504
 513 Mt Wellington Highway
 Mt Wellington, Auckland 1060

Christchurch Branch:

T: +64 3 349 3316
 F: +64 3 349 3317
 15 Edmonton Road
 Hornby, Christchurch 8042

Title **65x18.5mm Profile**

Drawing

RK123

Scale 1 : 2 @ A4 Date 20.11.2020

1. Profile for oiled or stained weatherboards only.
2. Profiles as per NZS 3617, Branz Bulletin 411 and/or compliance achieved through in-service history, length of service not less than 15 years in all NZ environments B2/VM1 1.1.1 (a).
3. Timber to comply with NZBC B2 Durability B2.3.1 (b).
4. Profiles shall be fixed in accordance with E2/AS1 Table 24.

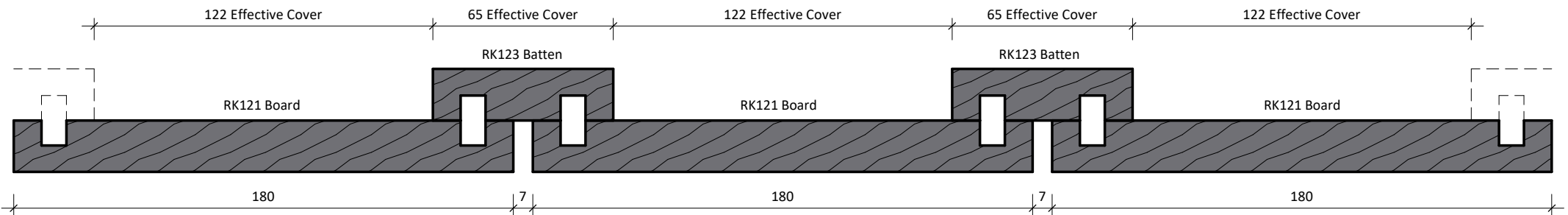
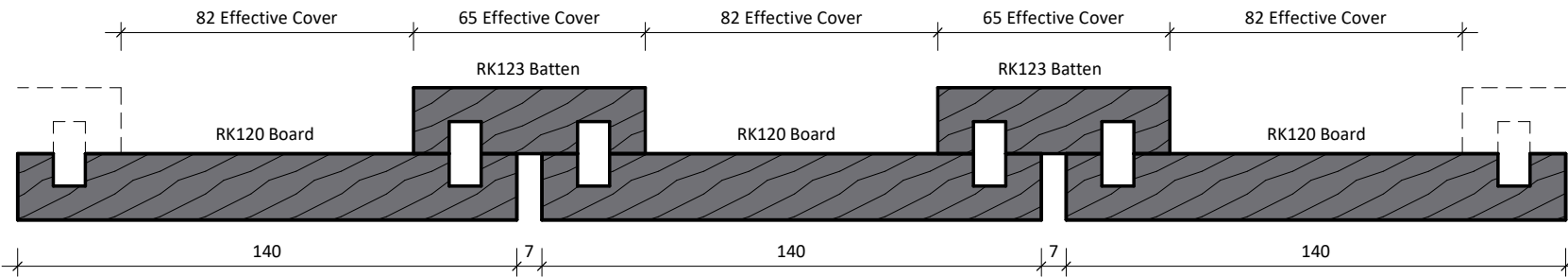
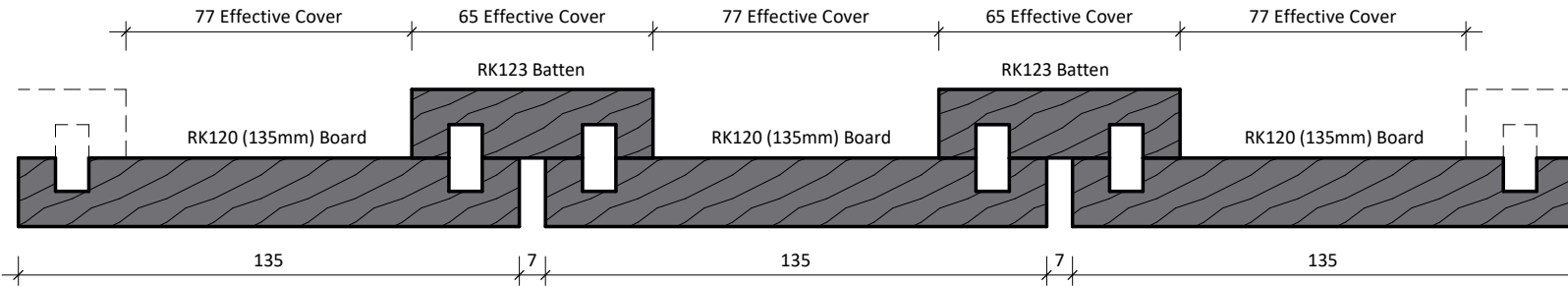

Finish:
 - BSF (Band sawn finish)
 - DFS (Dressed face sanded)



www.rosenfeldkidson.co.nz

Postal address: PO Box 621,
 Shortland Street, Auckland 1140

Auckland Branch:

T: +64 9 573 0503
 F: +64 9 573 0504
 513 Mt Wellington Highway
 Mt Wellington, Auckland 1060

Christchurch Branch:

T: +64 3 349 3316
 F: +64 3 349 3317
 15 Edmonton Road
 Hornby, Christchurch 8042

Title **140x18.5mm &
 65x18.5mm Profile**

Drawing **RK120-RK123**

Scale 1 : 2 @ A4 Date 20.11.2020