

RKA702 Rusticated Weatherboard - 20mm Cavity on Flexible Underlay



Drawing	Sheet Name	Date
Typical Details		
RRK-C-00	Index V1	12.10.2020
RRK-SETOUT	Weatherboard Setout	12.10.2020
RRK-C-BATT	RKR Battens	12.10.2020
RRK-FLG-01	Flashing Details	12.10.2020
RRK-FLG-02	Flashing Details	12.10.2020
RRK-FASCIA	Fascia Profiles	12.10.2020
RRK-MOULD	RK Profiles	12.10.2020
RRK-FIXINGS	RK Fixings	12.10.2020
Window Details		
RRK-C-01	Aluminium Head Detail	12.10.2020
RRK-C-02	Aluminium Jamb Detail	12.10.2020
RRK-C-02A	Aluminium Jamb Detail Option	12.10.2020
RRK-C-02B	Aluminium Jamb Detail Option	12.10.2020
RRK-C-03	Aluminium Sill Detail	12.10.2020
Internal Corner Details		
RRK-C-11	Internal Corner RK41 Detail - Option 1	12.10.2020
External Corner Details		
RRK-C-21	External Corner RK42 Detail - Option 1	12.10.2020
RRK-C-22	External Corner Detail - Option 2	12.10.2020
RRK-C-23	External Corner RK97 Detail - Option 3	12.10.2020
RRK-C-25	External Corner Detail - Option 5	12.10.2020
RRK-C-26	External Corner Detail - Option 6	12.10.2020
RRK-C-27	External Corner Detail - Option 7	12.10.2020
RRK-C-28	External Corner Detail - Option 8	12.10.2020
Horizontal Details		
RRK-C-31	Pipe Penetration Detail	12.10.2020
Vertical Details		
RRK-C-41	Bottom Plate Detail	12.10.2020
RRK-C-42	Top Plate to Soffit Detail	12.10.2020
RRK-C-43	Barge Detail	12.10.2020
RRK-C-44	Soffit Detail	12.10.2020
RRK-C-45	Parapet Detail	12.10.2020
RRK-C-47	Nail Fixing Detail	12.10.2020
RRK-C-49	Nail Fixing Detail (Paint Finish Only)	12.10.2020
Optional Details		
RRK-C-94	Random W+D External Corner Detail - Option	12.10.2020
RRK-C-95	Random W+D External Corner Detail - Option	12.10.2020



www.rosenfeldkidson.co.nz

Postal address: PO Box 621,
Shortland Street, Auckland 1140

Auckland Branch:
 T: +64 9 573 0503
 F: +64 9 573 0504
 513 Mt Wellington Highway
 Mt Wellington, Auckland 1060

Christchurch Branch:
 T: +64 3 349 3316
 F: +64 3 349 3317
 15 Edmonton Road
 Hornby, Christchurch 8042

Title **Index V1**

Drawing **RRK-C-00**

Scale @ A4 Date 12.10.2020

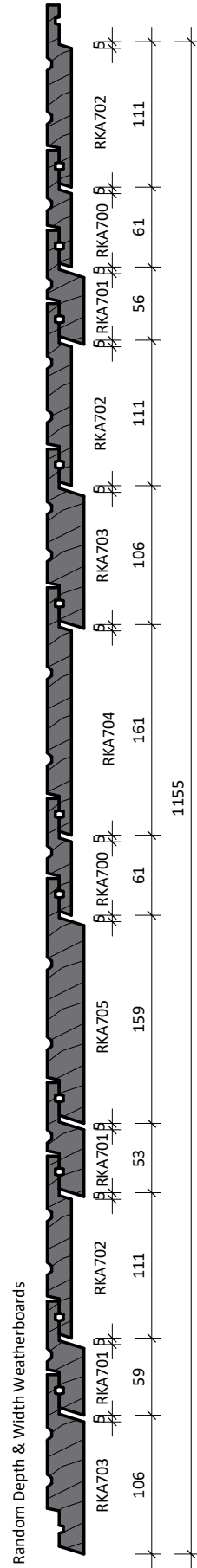
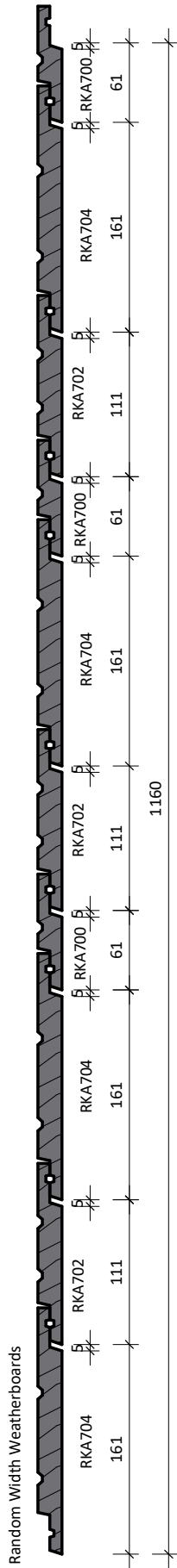
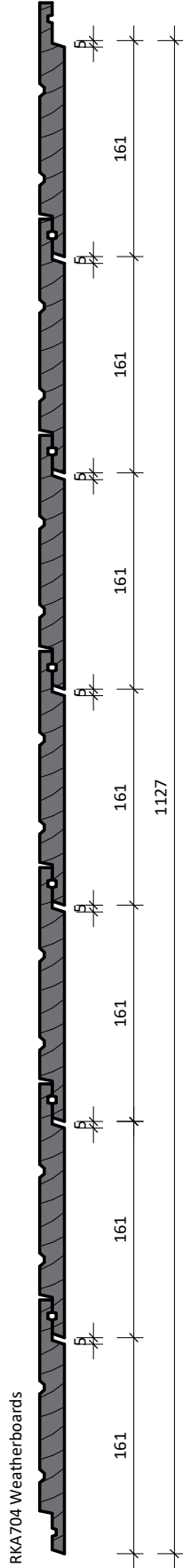
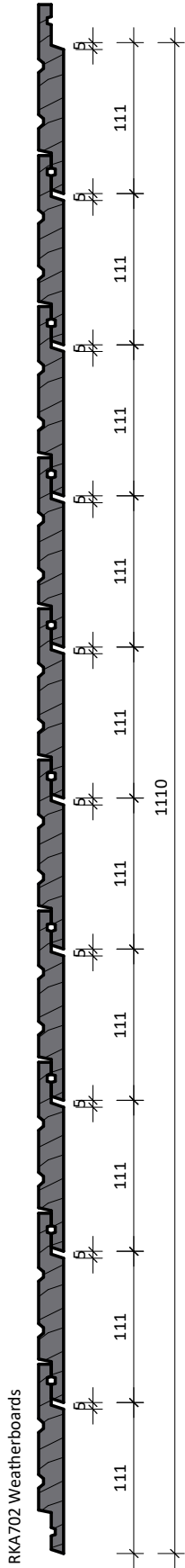

www.rosenfeldkidson.co.nz

Postal address: PO Box 621, Shortland Street, Auckland 1140

Auckland Branch:
T: +64 9 573 0503
F: +64 9 573 0504
513 Mt Wellington Highway
Mt Wellington, Auckland 1060

Christchurch Branch:
T: +64 3 349 3316
F: +64 3 349 3317
15 Edmonton Road
Hornby, Christchurch 8042

Title Weatherboard Setout

Drawing

RKR-SETOUT

Scale 1 : 5 @ A4

Date 12.10.2020

1. Scope as per Clauses 1.0 and 9.4 E2/AS1
2. Profiles as per NZS 3617, Branz Bulletin 411 and/or compliance achieved through in-service history, length of service not less than 15 years in all NZ environments B2/VM1 1.1.1 (a)
3. Fixings as per Table 24 E2/AS1
4. Compatibility of materials as per Tables 20-22 E2/AS1
5. Flashing as per Clause 4.0 E2/AS1
6. Rigid and flexible underlay as per Table 23 and Clauses 9.1.5 to 9.1.7 E2/AS1 or proprietary approved alternative
7. All weatherboards to be factory oiled to all faces and weathergrooves prior to installation, ensure maintenance is to manufacturers recommendations
8. The weatherboard system relies on the joinery meeting the requirements of NZS 4211 for the relevant building windzone or wind pressure
9. Timber to NZBC B2 Durability B2.3.1(b), Western Red Cedar, Larch and Truwood®
10. Timber framing to NZS 3604:2011

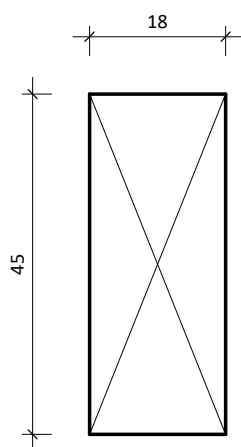

18x45mm Vertical timber cavity batten

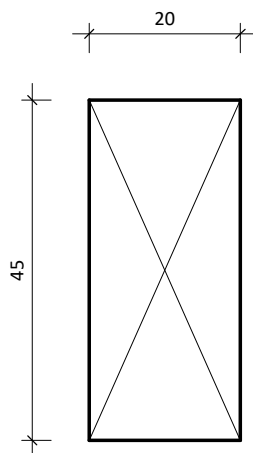

20x45mm Vertical timber cavity batten



www.rosenfeldkidson.co.nz

Postal address: PO Box 621,
Shortland Street, Auckland 1140

Auckland Branch:

T: +64 9 573 0503
F: +64 9 573 0504
513 Mt Wellington Highway
Mt Wellington, Auckland 1060

Christchurch Branch:

T: +64 3 349 3316
F: +64 3 349 3317
15 Edmonton Road
Hornby, Christchurch 8042

Title **RKR Battens**

Drawing

RKR-C-BATT

Scale 1 : 1 @ A4

Date 12.10.2020

1. Scope as per Clauses 1.0 and 9.4 E2/AS1
2. Profiles as per NZS 3617, Branz Bulletin 411 and/or compliance achieved through in-service history, length of service not less than 15 years in all NZ environments B2/VM1 1.1.1 (a)
3. Fixings as per Table 24 E2/AS1
4. Compatibility of materials as per Tables 20-22 E2/AS1
5. Flashing as per Clause 4.0 E2/AS1
6. Rigid and flexible underlay as per Table 23 and Clauses 9.1.5 to 9.1.7 E2/AS1 or proprietary approved alternative
7. All weatherboards to be factory oiled to all faces and weathergrooves prior to installation, ensure maintenance is to manufacturers recommendations
8. The weatherboard system relies on the joinery meeting the requirements of NZS 4211 for the relevant building windzone or wind pressure
9. Timber to NZBC B2 Durability B2.3.1(b), Western Red Cedar, Larch and Truwood®
10. Timber framing to NZS 3604:2011

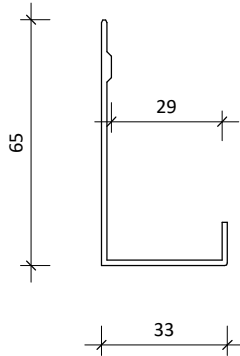

RKFL-17 powder coated aluminium jamb flashing.

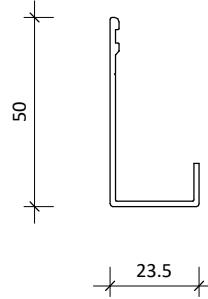

RKFL-11 powder coated aluminum jamb flashing

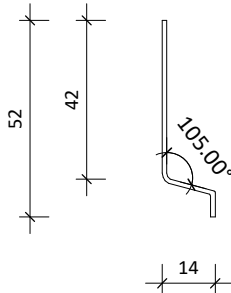

RKFL-12 42x14mm Cavity closer. Tack cavity closer @ 600mm crs

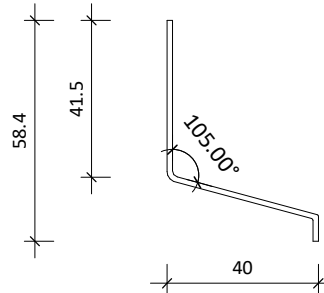

RKFL-14 Cavity closer. Tack cavity closer @ 600mm crs

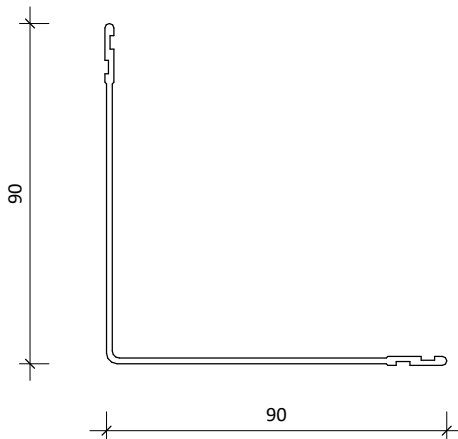

RKFL-10 internal/ external corner back flashing to suit extra high wind zone

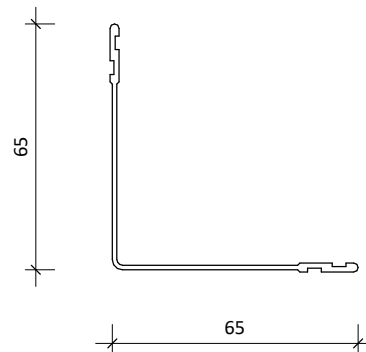

RKFL-09 65x65mm internal/ external corner back flashing



www.rosenfeldkidson.co.nz

Postal address: PO Box 621,
Shortland Street, Auckland 1140

Auckland Branch:
T: +64 9 573 0503
F: +64 9 573 0504
513 Mt Wellington Highway
Mt Wellington, Auckland 1060

Christchurch Branch:
T: +64 3 349 3316
F: +64 3 349 3317
15 Edmonton Road
Hornby, Christchurch 8042

Title **Flashing Details**

Drawing

RKR-FLG-01

Scale 1 : 2 @ A4

Date 12.10.2020

1. Scope as per Clauses 1.0 and 9.4 E2/AS1
2. Profiles as per NZS 3617, Branz Bulletin 411 and/or compliance achieved through in-service history, length of service not less than 15 years in all NZ environments B2/VM1 1.1.1 (a)
3. Fixings as per Table 24 E2/AS1
4. Compatibility of materials as per Tables 20-22 E2/AS1
5. Flashing as per Clause 4.0 E2/AS1
6. Rigid and flexible underlay as per Table 23 and Clauses 9.1.5 to 9.1.7 E2/AS1 or proprietary approved alternative
7. All weatherboards to be factory oiled to all faces and weathergrooves prior to installation, ensure maintenance is to manufacturers recommendations
8. The weatherboard system relies on the joinery meeting the requirements of NZS 4211 for the relevant building windzone or wind pressure
9. Timber to NZBC B2 Durability B2.3.1(b), Western Red Cedar, Larch and Truwood®
10. Timber framing to NZS 3604:2011

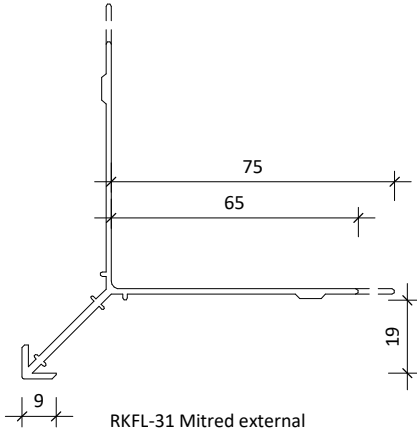

RKFL-31 Mitred external corner back flashing, or RKFL-31L in extra high wind zone

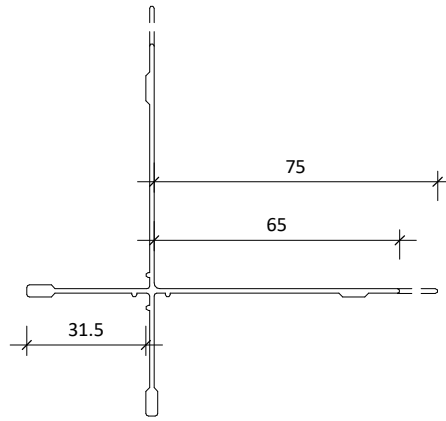

RKFL-34 External corner back flashing, or RKFL-34L in extra high wind zone

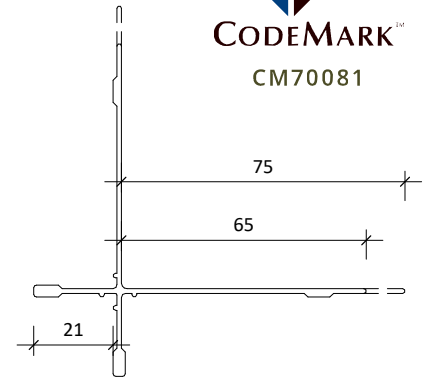

RKFL-35 External corner back flashing, or RKFL-35L in extra high wind zone

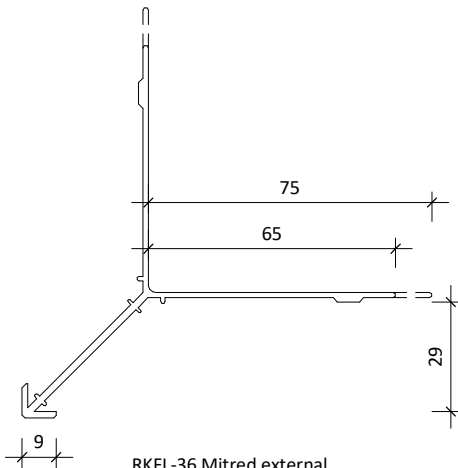

RKFL-36 Mitred external corner back flashing, or RKFL-36L in extra high wind zone

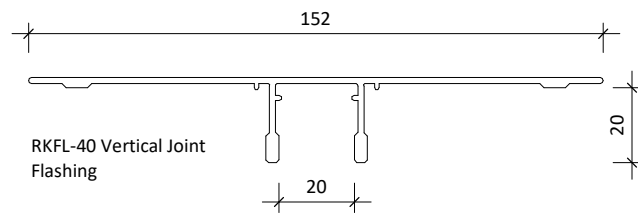

RKFL-40 Vertical Joint Flashing



www.rosenfeldkidson.co.nz

Postal address: PO Box 621,
Shortland Street, Auckland 1140

Auckland Branch:
T: +64 9 573 0503
F: +64 9 573 0504
513 Mt Wellington Highway
Mt Wellington, Auckland 1060

Christchurch Branch:
T: +64 3 349 3316
F: +64 3 349 3317
15 Edmonton Road
Hornby, Christchurch 8042

Title **Flashing Details**

Drawing

RKR-FLG-02

Scale 1 : 2 @ A4 Date 12.10.2020

1. Scope as per Clauses 1.0 and 9.4 E2/AS1
2. Profiles as per NZS 3617, Branz Bulletin 411 and/or compliance achieved through in-service history, length of service not less than 15 years in all NZ environments B2/VM1 1.1.1 (a)
3. Fixings as per Table 24 E2/AS1
4. Compatibility of materials as per Tables 20-22 E2/AS1
5. Flashing as per Clause 4.0 E2/AS1
6. Rigid and flexible underlay as per Table 23 and Clauses 9.1.5 to 9.1.7 E2/AS1 or proprietary approved alternative
7. All weatherboards to be factory oiled to all faces and weathergrooves prior to installation, ensure maintenance is to manufacturers recommendations
8. The weatherboard system relies on the joinery meeting the requirements of NZS 4211 for the relevant building windzone or wind pressure
9. Timber to NZBC B2 Durability B2.3.1(b), Western Red Cedar, Larch and Truwood®
10. Timber framing to NZS 3604:2011

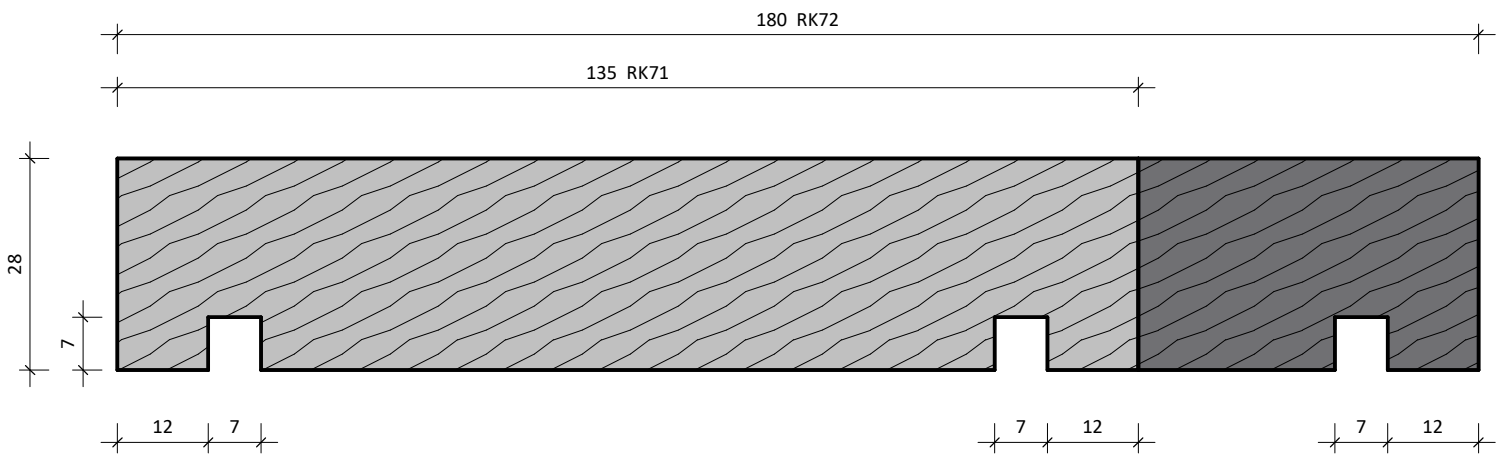
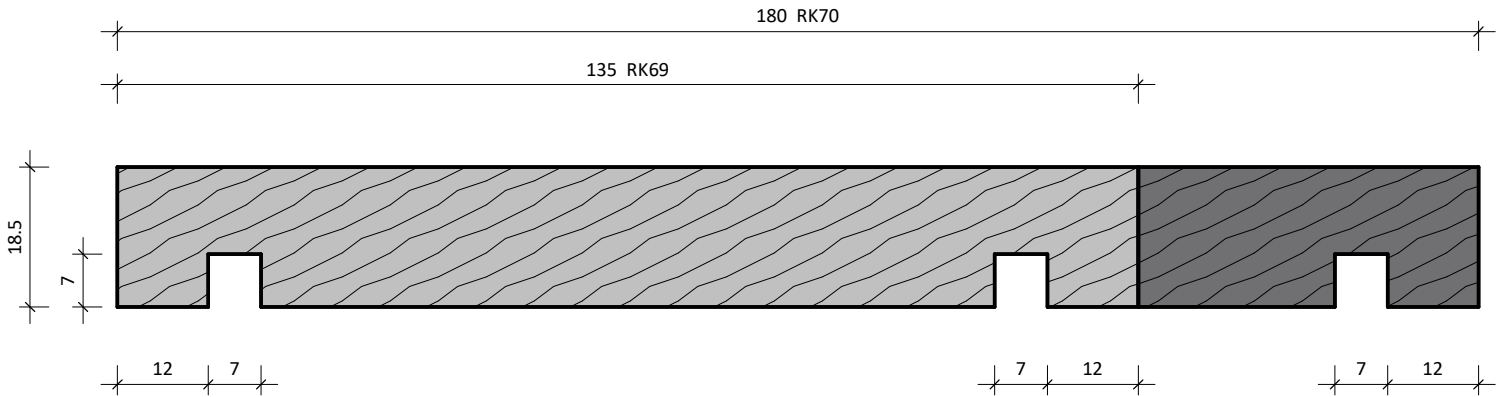

www.rosenfeldkidson.co.nz

Postal address: PO Box 621,
Shortland Street, Auckland 1140

Auckland Branch:
 T: +64 9 573 0503
 F: +64 9 573 0504
 513 Mt Wellington Highway
 Mt Wellington, Auckland 1060

Christchurch Branch:
 T: +64 3 349 3316
 F: +64 3 349 3317
 15 Edmonton Road
 Hornby, Christchurch 8042

Title **Fascia Profiles**

Drawing

RKR-FASCIA

Scale 1 : 1 @ A4

Date 12.10.2020

1. Scope as per Clauses 1.0 and 9.4 E2/AS1
2. Profiles as per NZS 3617, Branz Bulletin 411 and/or compliance achieved through in-service history, length of service not less than 15 years in all NZ environments B2/VM1 1.1.1 (a)
3. Fixings as per Table 24 E2/AS1
4. Compatibility of materials as per Tables 20-22 E2/AS1
5. Flashing as per Clause 4.0 E2/AS1
6. Rigid and flexible underlay as per Table 23 and Clauses 9.1.5 to 9.1.7 E2/AS1 or proprietary approved alternative
7. All weatherboards to be factory oiled to all faces and weathergrooves prior to installation, ensure maintenance is to manufacturers recommendations
8. The weatherboard system relies on the joinery meeting the requirements of NZS 4211 for the relevant building windzone or wind pressure
9. Timber to NZBC B2 Durability B2.3.1(b), Western Red Cedar, Larch and Truwood®
10. Timber framing to NZS 3604:2011

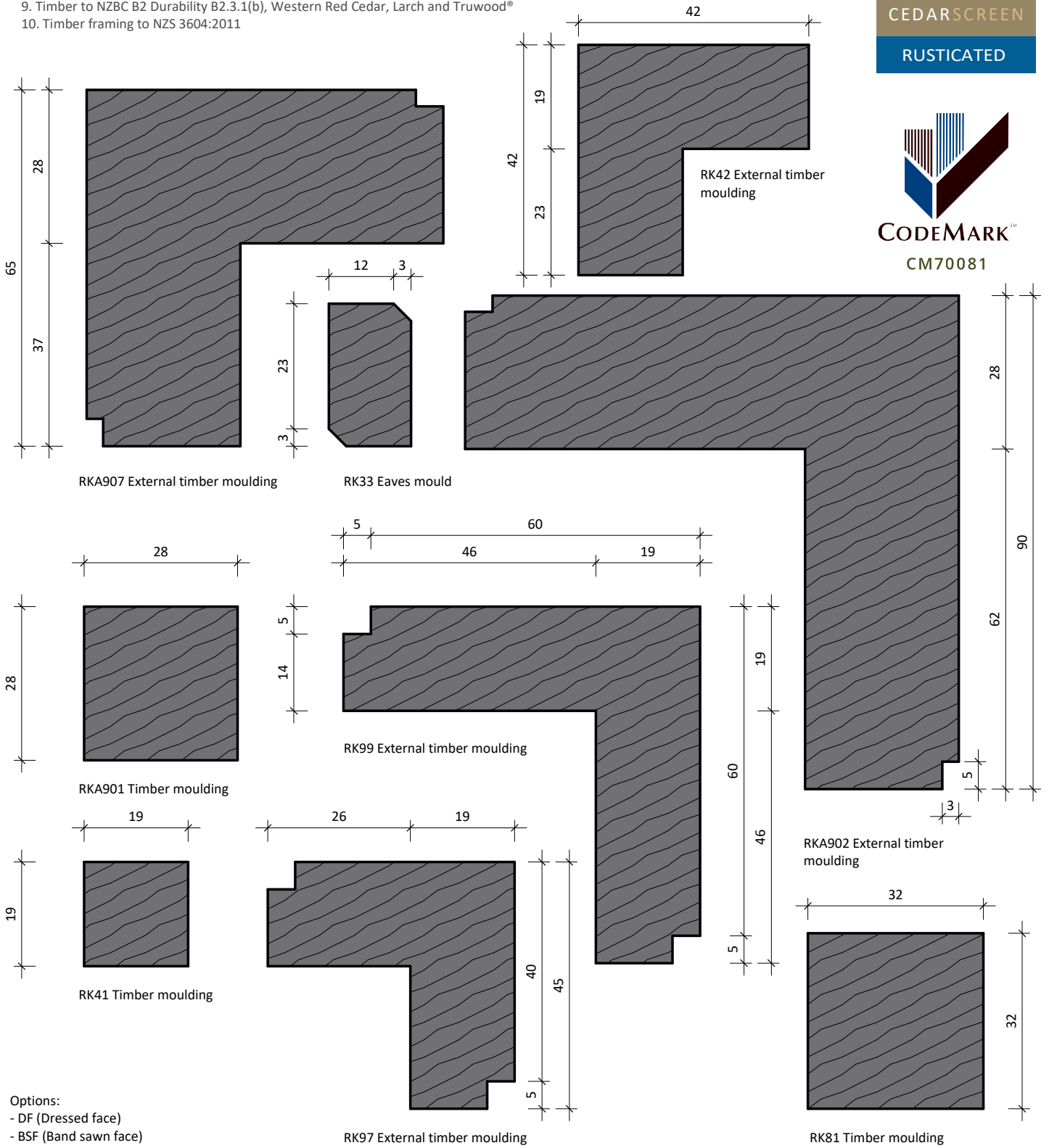

Options:
 - DF (Dressed face)
 - BSF (Band sawn face)



www.rosenfeldkidson.co.nz

Postal address: PO Box 621,
 Shortland Street, Auckland 1140

Auckland Branch:
 T: +64 9 573 0503
 F: +64 9 573 0504
 513 Mt Wellington Highway
 Mt Wellington, Auckland 1060

Christchurch Branch:
 T: +64 3 349 3316
 F: +64 3 349 3317
 15 Edmonton Road
 Hornby, Christchurch 8042

Title **RK Profiles**

Drawing

RKR-MOULD

Scale 1 : 1 @ A4

Date 12.10.2020

1. Scope as per Clauses 1.0 and 9.4 E2/AS1
2. Profiles as per NZS 3617, Branz Bulletin 411 and/or compliance achieved through in-service history, length of service not less than 15 years in all NZ environments B2/VM1 1.1.1 (a)
3. Fixings as per Table 24 E2/AS1
4. Compatibility of materials as per Tables 20-22 E2/AS1
5. Flashing as per Clause 4.0 E2/AS1
6. Rigid and flexible underlay as per Table 23 and Clauses 9.1.5 to 9.1.7 E2/AS1 or proprietary approved alternative
7. All weatherboards to be factory oiled to all faces and weathergrooves prior to installation, ensure maintenance is to manufacturers recommendations
8. The weatherboard system relies on the joinery meeting the requirements of NZS 4211 for the relevant building windzone or wind pressure
9. Timber to NZBC B2 Durability B2.3.1(b), Western Red Cedar, Larch and Truwood®
10. Timber framing to NZS 3604:2011



RK Cladding Fixings

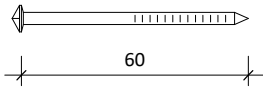

Direct fixed 60 x 3.15mm

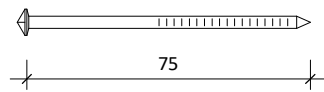

Flexible underlay 75 x 3.15mm

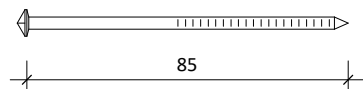

Rigid underlay 85 x 3.15mm

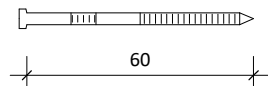

Cavity fixed 60 x 3.15mm Stainless steel nail
Jolthead nail for paint finish weatherboards.

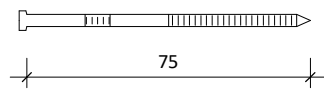

Cavity fixed 75 x 3.15mm Stainless steel nail
Jolthead nail for paint finish weatherboards.

RK Plug Nail Range

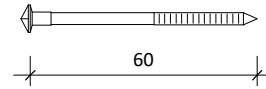

Cedarscreen Plug Nail 60 x 3.15mm

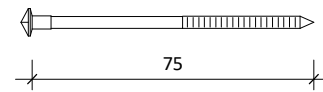

Cedarscreen Plug Nail 75 x 3.15mm

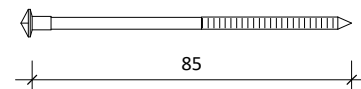

Cedarscreen Plug Nail 85 x 3.15mm

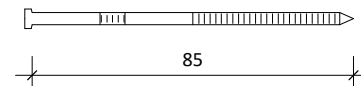

Cavity fixed 85 x 3.15mm Stainless steel nail
Jolthead nail for paint finish weatherboards.

RK Structural Fixings

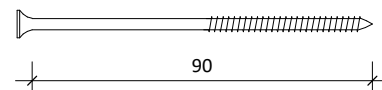

- ASSY 90x12g Stainless steel screws
- RK-S2 90x12g Stainless steel screws

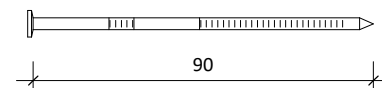

90 x 3.30mm Stainless steel 316 Annular groove nail



Options:

- Silicon bronze annular grooved
- Stainless steel 316 grade annular grooved
- All fixings to be annular groove



www.rosenfeldkidson.co.nz

Postal address: PO Box 621,
Shortland Street, Auckland 1140

Auckland Branch:

T: +64 9 573 0503
F: +64 9 573 0504
513 Mt Wellington Highway
Mt Wellington, Auckland 1060

Christchurch Branch:

T: +64 3 349 3316
F: +64 3 349 3317
15 Edmonton Road
Hornby, Christchurch 8042

Title **RK Fixings**

Drawing

RKR-FIXINGS

Scale 1 : 2 @ A4

Date 12.10.2020

1. Scope as per Clauses 1.0 and 9.4 E2/AS1
2. Profiles as per NZS 3617, Branz Bulletin 411 and/or compliance achieved through in-service history, length of service not less than 15 years in all NZ environments B2/VM1 1.1.1 (a)
3. Fixings as per Table 24 E2/AS1
4. Compatibility of materials as per Tables 20-22 E2/AS1
5. Flashing as per Clause 4.0 E2/AS1
6. Rigid and flexible underlay as per Table 23 and Clauses 9.1.5 to 9.1.7 E2/AS1 or proprietary approved alternative
7. All weatherboards to be factory oiled to all faces and weathergrooves prior to installation, ensure maintenance is to manufacturers recommendations
8. The weatherboard system relies on the joinery meeting the requirements of NZS 4211 for the relevant building windzone or wind pressure
9. Timber to NZBC B2 Durability B2.3.1(b), Western Red Cedar, Larch and Truwood®
10. Timber framing to NZS 3604:2011



Flexible wall underlay. As per Table 23 and Clause 9.1.5 to 9.1.7.1 E2/AS1

Timber framing

Internal wall lining

RKFL-12 42x14mm Cavity closer. Tack cavity closer @ 600mm crs

Proprietary prefolded head flashing with 15° fall

Head flashing turned up to form stop end

10

Continuous air seal

Temporary packer

Flashing tape over head flashing

RKA702 Rusticated Weatherboard

75mm Cover to flashing for extra high wind zones

For extra high wind zone only head flashing is bedded on continuous bead of sealant. Refer Page 104 fig 71 E2/AS1

40

35mm Min. Cover to Flashing

Flexible flashing tape over flexible wall underlay. As per Clause 9.1.5 (a) (b) and figure 72A and 72B E2/AS1

Line of jamb scribe

Window joinery supplied by others

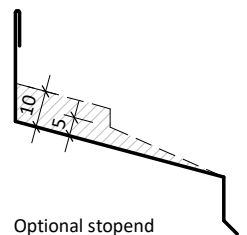

Optional stop end

interactive assembly instructions available
<http://wksp.nz/rk-hrw-rkrc02a>



get WorkingSpec from Apple App Store or Google Play



www.rosenfeldkidson.co.nz

Postal address: PO Box 621, Shortland Street, Auckland 1140

Auckland Branch:

T: +64 9 573 0503

F: +64 9 573 0504

513 Mt Wellington Highway

Mt Wellington, Auckland 1060

Christchurch Branch:

T: +64 3 349 3316

F: +64 3 349 3317

15 Edmonton Road

Hornby, Christchurch 8042

Title **Aluminium Head Detail**

Drawing

RKR-C-01

Scale 1 : 2 @ A4

Date 12.10.2020

1. Scope as per Clauses 1.0 and 9.4 E2/AS1
2. Profiles as per NZS 3617, Branz Bulletin 411 and/or compliance achieved through in-service history, length of service not less than 15 years in all NZ environments B2/VM1 1.1.1 (a)
3. Fixings as per Table 24 E2/AS1
4. Compatibility of materials as per Tables 20-22 E2/AS1
5. Flashing as per Clause 4.0 E2/AS1
6. Rigid and flexible underlay as per Table 23 and Clauses 9.1.5 to 9.1.7 E2/AS1 or proprietary approved alternative
7. All weatherboards to be factory oiled to all faces and weathergrooves prior to installation, ensure maintenance is to manufacturers recommendations
8. The weatherboard system relies on the joinery meeting the requirements of NZS 4211 for the relevant building windzone or wind pressure
9. Timber to NZBC B2 Durability B2.3.1(b), Western Red Cedar, Larch and Truwood®
10. Timber framing to NZS 3604:2011

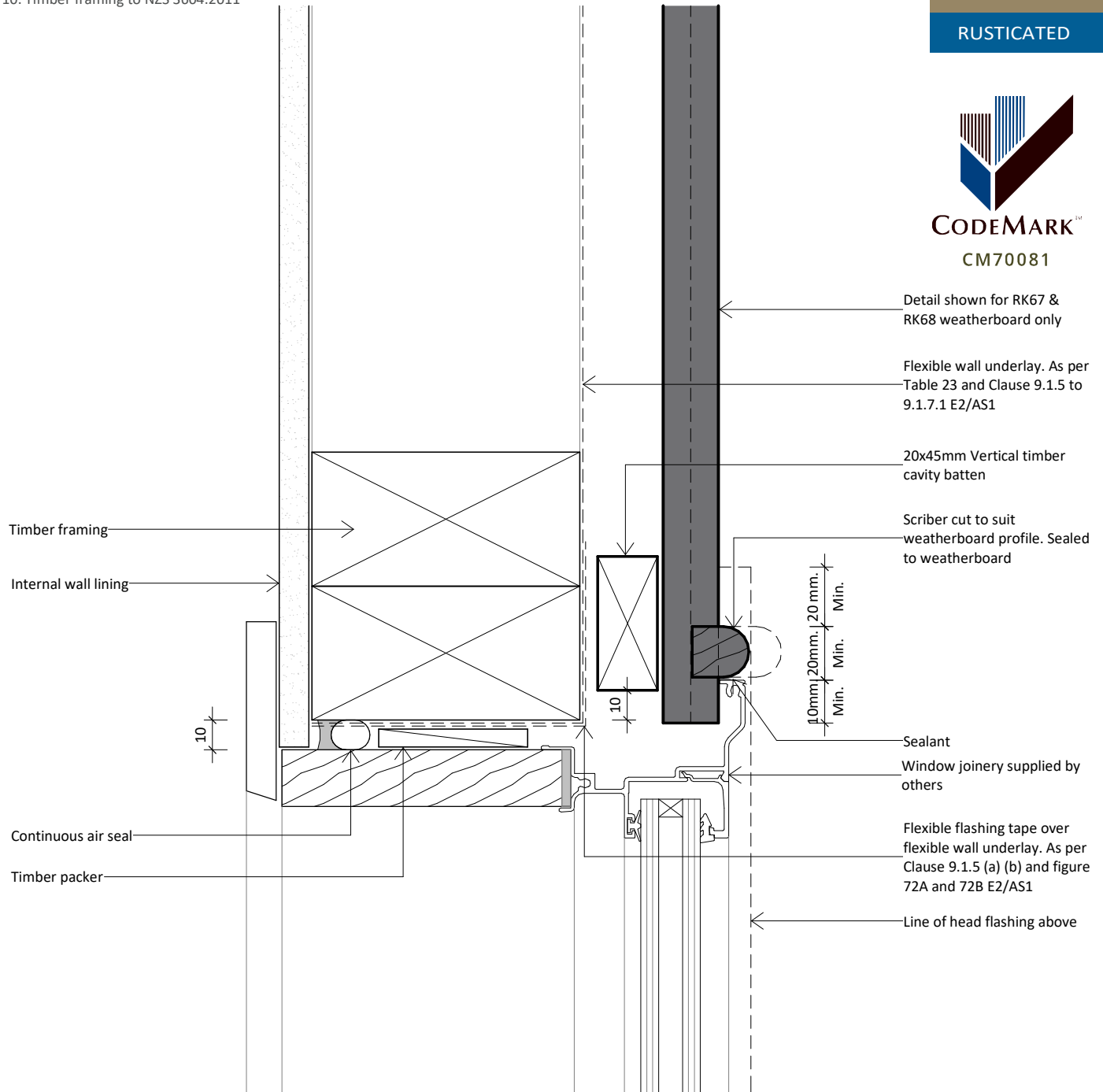

www.rosenfeldkidson.co.nz

Postal address: PO Box 621,
Shortland Street, Auckland 1140

Auckland Branch:
 T: +64 9 573 0503
 F: +64 9 573 0504
 513 Mt Wellington Highway
 Mt Wellington, Auckland 1060

Christchurch Branch:
 T: +64 3 349 3316
 F: +64 3 349 3317
 15 Edmonton Road
 Hornby, Christchurch 8042

Title **Aluminium Jamb Detail**

Drawing
RKR-C-02

Scale 1 : 2 @ A4 Date 12.10.2020

1. Scope as per Clauses 1.0 and 9.4 E2/AS1
2. Profiles as per NZS 3617, Branz Bulletin 411 and/or compliance achieved through in-service history, length of service not less than 15 years in all NZ environments B2/VM1 1.1.1 (a)
3. Fixings as per Table 24 E2/AS1
4. Compatibility of materials as per Tables 20-22 E2/AS1
5. Flashing as per Clause 4.0 E2/AS1
6. Rigid and flexible underlay as per Table 23 and Clauses 9.1.5 to 9.1.7 E2/AS1 or proprietary approved alternative
7. All weatherboards to be factory oiled to all faces and weathergrooves prior to installation, ensure maintenance is to manufacturers recommendations
8. The weatherboard system relies on the joinery meeting the requirements of NZS 4211 for the relevant building windzone or wind pressure
9. Timber to NZBC B2 Durability B2.3.1(b), Western Red Cedar, Larch and Truwood®
10. Timber framing to NZS 3604:2011

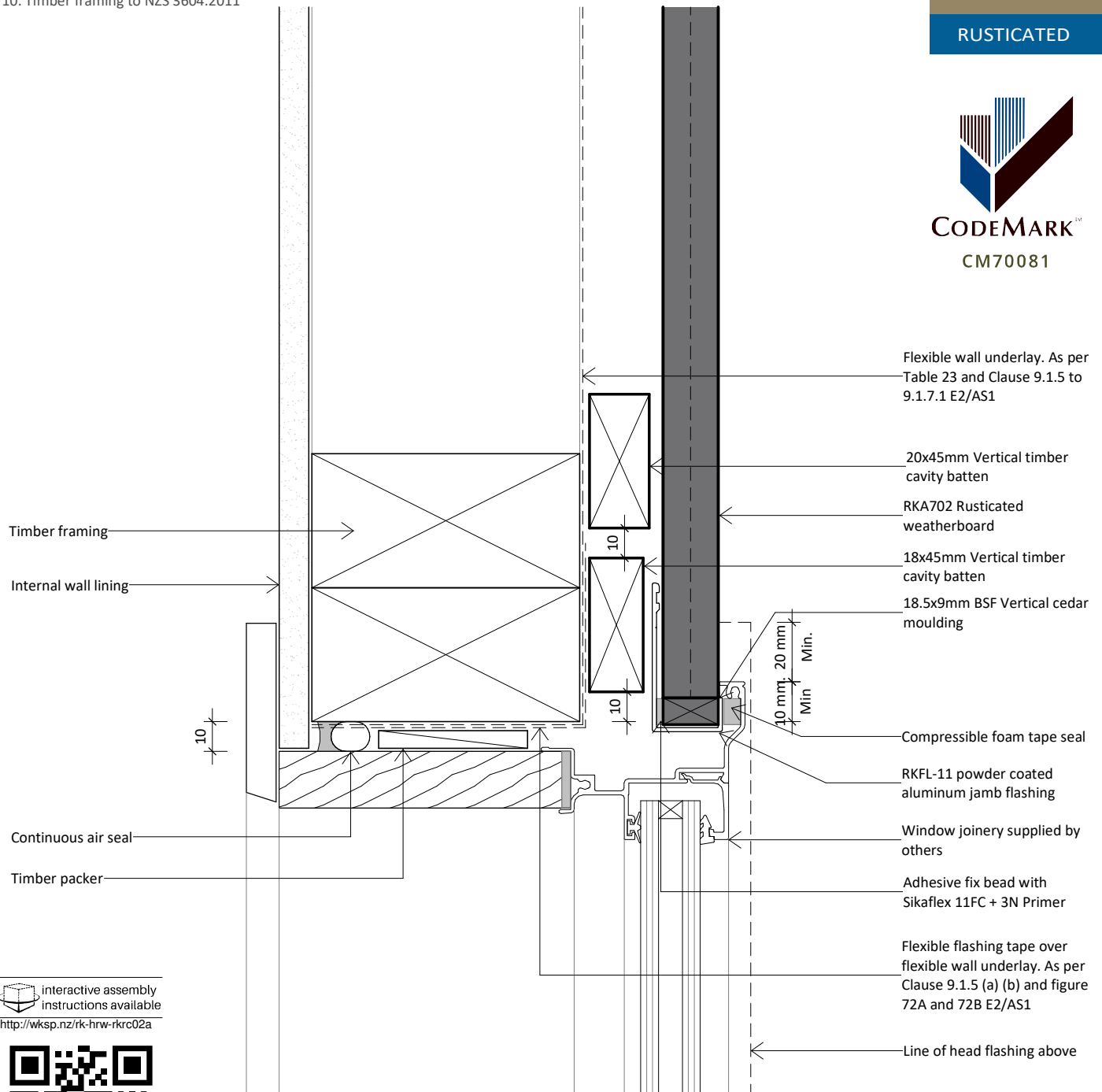

interactive assembly instructions available
<http://wksp.nz/rk-hrw-rkrc02a>



get WorkingSpec from
 Apple App Store or Google Play



www.rosenfeldkidson.co.nz

Postal address: PO Box 621,
 Shortland Street, Auckland 1140

Auckland Branch:
 T: +64 9 573 0503
 F: +64 9 573 0504
 513 Mt Wellington Highway
 Mt Wellington, Auckland 1060

Christchurch Branch:
 T: +64 3 349 3316
 F: +64 3 349 3317
 15 Edmonton Road
 Hornby, Christchurch 8042

Title **Aluminium Jamb Detail
 Option**

Drawing
RKR-C-02A

Scale 1 : 2 @ A4 Date 12.10.2020

1. Scope as per Clauses 1.0 and 9.4 E2/AS1
2. Profiles as per NZS 3617, Branz Bulletin 411 and/or compliance achieved through in-service history, length of service not less than 15 years in all NZ environments B2/VM1 1.1.1 (a)
3. Fixings as per Table 24 E2/AS1
4. Compatibility of materials as per Tables 20-22 E2/AS1
5. Flashing as per Clause 4.0 E2/AS1
6. Rigid and flexible underlay as per Table 23 and Clauses 9.1.5 to 9.1.7 E2/AS1 or proprietary approved alternative
7. All weatherboards to be factory oiled to all faces and weathergrooves prior to installation, ensure maintenance is to manufacturers recommendations
8. The weatherboard system relies on the joinery meeting the requirements of NZS 4211 for the relevant building windzone or wind pressure
9. Timber to NZBC B2 Durability B2.3.1(b), Western Red Cedar, Larch and Truwood®
10. Timber framing to NZS 3604:2011

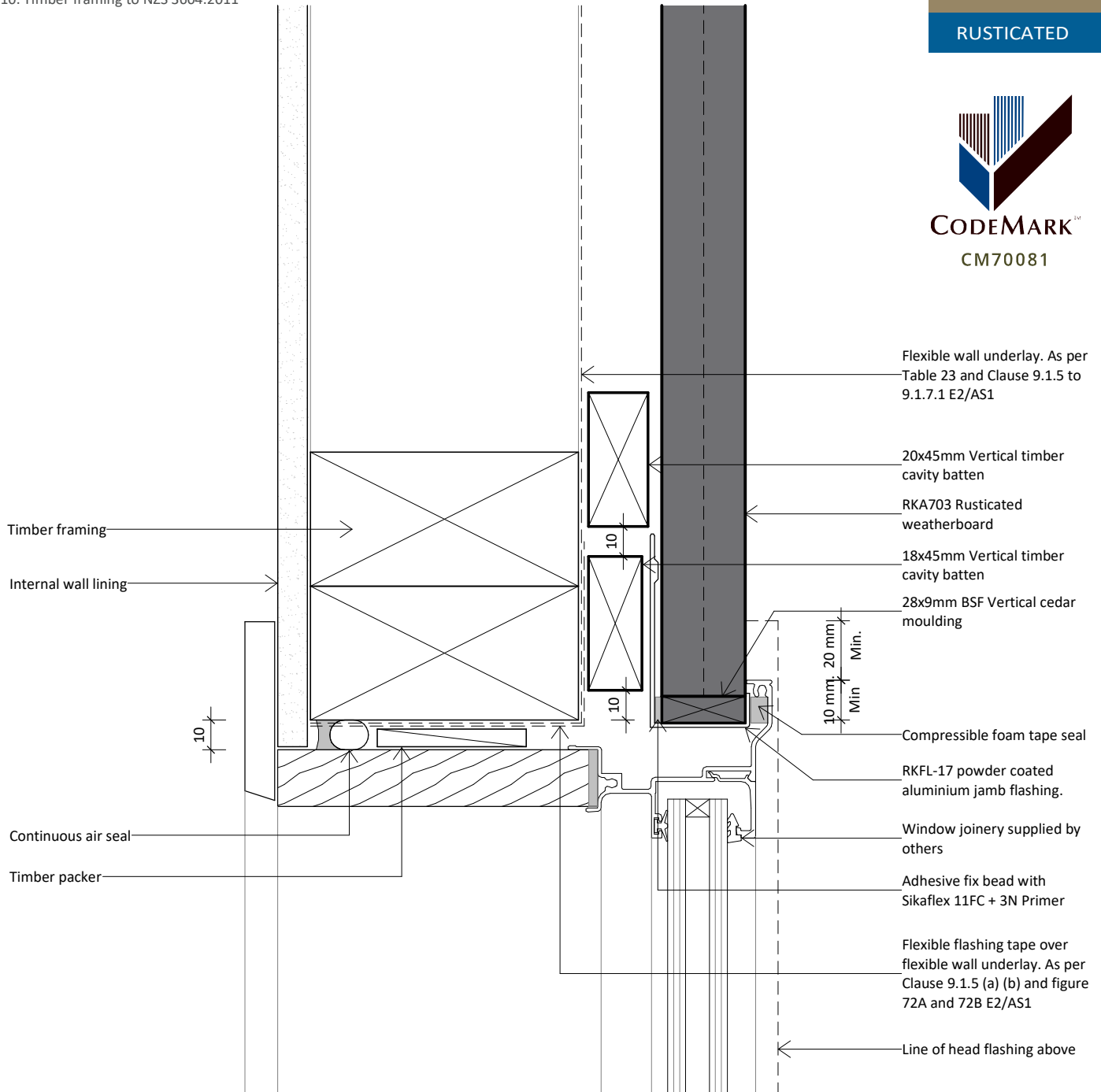

www.rosenfeldkidson.co.nz

Postal address: PO Box 621,
Shortland Street, Auckland 1140

Auckland Branch:
T: +64 9 573 0503
F: +64 9 573 0504
513 Mt Wellington Highway
Mt Wellington, Auckland 1060

Christchurch Branch:
T: +64 3 349 3316
F: +64 3 349 3317
15 Edmonton Road
Hornby, Christchurch 8042

Title **Aluminium Jamb Detail Option**

Drawing **RKR-C-02B**

Scale 1 : 2 @ A4 Date 12.10.2020

1. Scope as per Clauses 1.0 and 9.4 E2/AS1
2. Profiles as per NZS 3617, Branz Bulletin 411 and/or compliance achieved through in-service history, length of service not less than 15 years in all NZ environments B2/VM1 1.1.1 (a)
3. Fixings as per Table 24 E2/AS1
4. Compatibility of materials as per Tables 20-22 E2/AS1
5. Flashing as per Clause 4.0 E2/AS1
6. Rigid and flexible underlay as per Table 23 and Clauses 9.1.5 to 9.1.7 E2/AS1 or proprietary approved alternative
7. All weatherboards to be factory oiled to all faces and weathergrooves prior to installation, ensure maintenance is to manufacturers recommendations
8. The weatherboard system relies on the joinery meeting the requirements of NZS 4211 for the relevant building windzone or wind pressure
9. Timber to NZBC B2 Durability B2.3.1(b), Western Red Cedar, Larch and Truwood®
10. Timber framing to NZS 3604:2011



Flexible flashing tape over flexible wall underlay. As per Clause 9.1.5 (a) (b) and figure 72A and 72B E2/AS1

Timber packer

Continuous air seal

10

Timber framing

Internal wall lining

Window joinery supplied by others

Support bar to suit joinery type

10mm Min

20x45mm Vertical timber cavity batten

Flexible wall underlay. As per Table 23 and Clause 9.1.5 to 9.1.7.1 E2/AS1

RKA702 Rusticated weatherboard

interactive assembly instructions available
<http://wksp.nz/rk-hrw-rkrc02a>



get WorkingSpec from Apple App Store or Google Play



www.rosenfeldkidson.co.nz

Postal address: PO Box 621,
Shortland Street, Auckland 1140

Auckland Branch:

T: +64 9 573 0503

F: +64 9 573 0504

513 Mt Wellington Highway

Mt Wellington, Auckland 1060

Christchurch Branch:

T: +64 3 349 3316

F: +64 3 349 3317

15 Edmonton Road

Hornby, Christchurch 8042

Title **Aluminium Sill Detail**

Drawing

RKR-C-03

Scale 1 : 2 @ A4

Date 12.10.2020

1. Scope as per Clauses 1.0 and 9.4 E2/AS1
2. Profiles as per NZS 3617, Branz Bulletin 411 and/or compliance achieved through in-service history, length of service not less than 15 years in all NZ environments B2/VM1 1.1.1 (a)
3. Fixings as per Table 24 E2/AS1
4. Compatibility of materials as per Tables 20-22 E2/AS1
5. Flashing as per Clause 4.0 E2/AS1
6. Rigid and flexible underlay as per Table 23 and Clauses 9.1.5 to 9.1.7 E2/AS1 or proprietary approved alternative
7. All weatherboards to be factory oiled to all faces and weathergrooves prior to installation, ensure maintenance is to manufacturers recommendations
8. The weatherboard system relies on the joinery meeting the requirements of NZS 4211 for the relevant building windzone or wind pressure
9. Timber to NZBC B2 Durability B2.3.1(b), Western Red Cedar, Larch and Truwood®
10. Timber framing to NZS 3604:2011

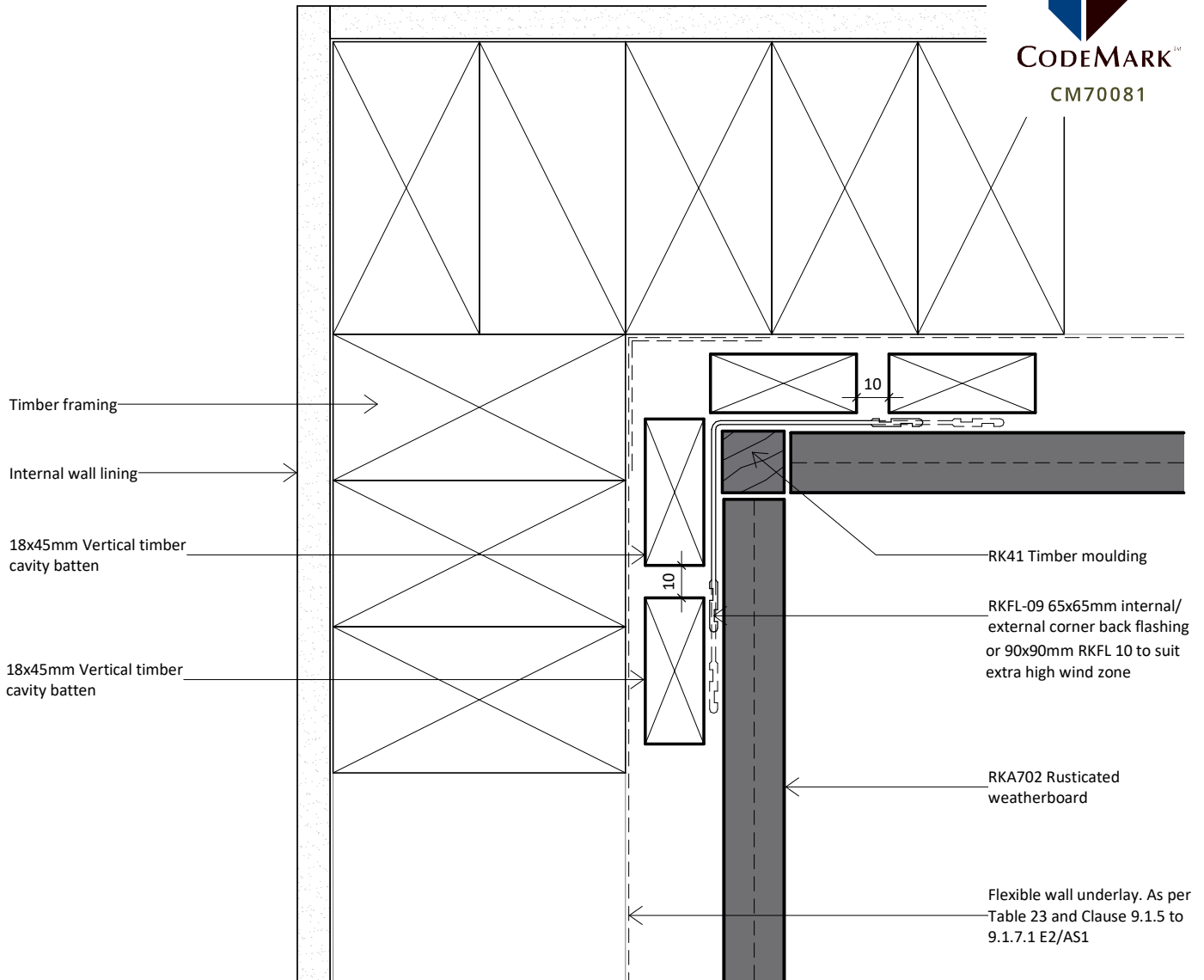

www.rosenfeldkidson.co.nz

Postal address: PO Box 621,
Shortland Street, Auckland 1140

Auckland Branch:
T: +64 9 573 0503
F: +64 9 573 0504
513 Mt Wellington Highway
Mt Wellington, Auckland 1060

Christchurch Branch:
T: +64 3 349 3316
F: +64 3 349 3317
15 Edmonton Road
Hornby, Christchurch 8042

Title **Internal Corner RK41 Detail
- Option 1**

Drawing
RKR-C-11

Scale 1 : 2 @ A4 Date 12.10.2020

1. Scope as per Clauses 1.0 and 9.4 E2/AS1
2. Profiles as per NZS 3617, Branz Bulletin 411 and/or compliance achieved through in-service history, length of service not less than 15 years in all NZ environments B2/VM1 1.1.1 (a)
3. Fixings as per Table 24 E2/AS1
4. Compatibility of materials as per Tables 20-22 E2/AS1
5. Flashing as per Clause 4.0 E2/AS1
6. Rigid and flexible underlay as per Table 23 and Clauses 9.1.5 to 9.1.7 E2/AS1 or proprietary approved alternative
7. All weatherboards to be factory oiled to all faces and weathergrooves prior to installation, ensure maintenance is to manufacturers recommendations
8. The weatherboard system relies on the joinery meeting the requirements of NZS 4211 for the relevant building windzone or wind pressure
9. Timber to NZBC B2 Durability B2.3.1(b), Western Red Cedar, Larch and Truwood®
10. Timber framing to NZS 3604:2011

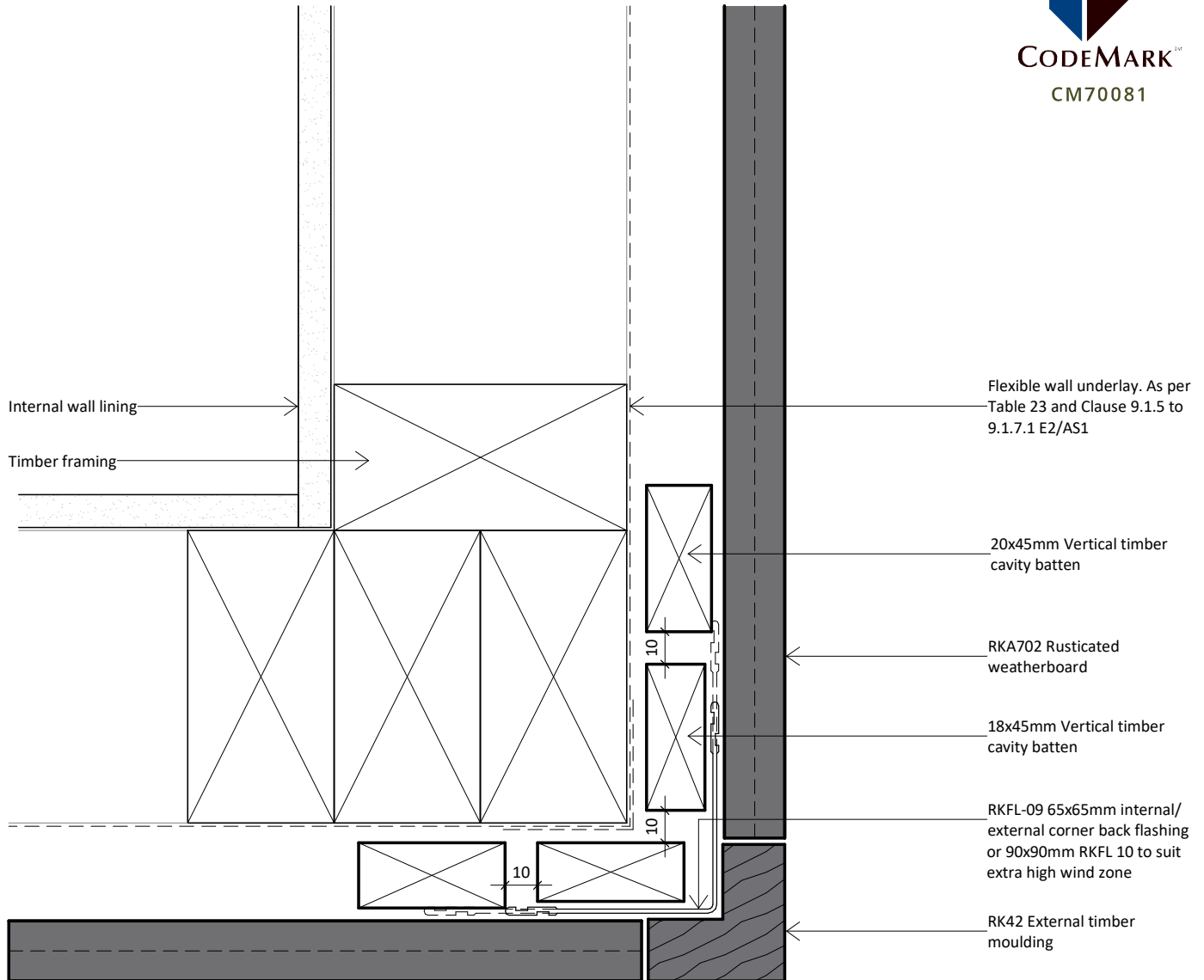

www.rosenfeldkidson.co.nz

Postal address: PO Box 621,
Shortland Street, Auckland 1140

Auckland Branch:
T: +64 9 573 0503
F: +64 9 573 0504
513 Mt Wellington Highway
Mt Wellington, Auckland 1060

Christchurch Branch:
T: +64 3 349 3316
F: +64 3 349 3317
15 Edmonton Road
Hornby, Christchurch 8042

Title **External Corner RK42
Detail - Option 1**

Drawing
RKR-C-21

Scale 1 : 2 @ A4 Date 12.10.2020

1. Scope as per Clauses 1.0 and 9.4 E2/AS1
2. Profiles as per NZS 3617, Branz Bulletin 411 and/or compliance achieved through in-service history, length of service not less than 15 years in all NZ environments B2/VM1 1.1.1 (a)
3. Fixings as per Table 24 E2/AS1
4. Compatibility of materials as per Tables 20-22 E2/AS1
5. Flashing as per Clause 4.0 E2/AS1
6. Rigid and flexible underlay as per Table 23 and Clauses 9.1.5 to 9.1.7 E2/AS1 or proprietary approved alternative
7. All weatherboards to be factory oiled to all faces and weathergrooves prior to installation, ensure maintenance is to manufacturers recommendations
8. The weatherboard system relies on the joinery meeting the requirements of NZS 4211 for the relevant building windzone or wind pressure
9. Timber to NZBC B2 Durability B2.3.1(b), Western Red Cedar, Larch and Truwood®
10. Timber framing to NZS 3604:2011

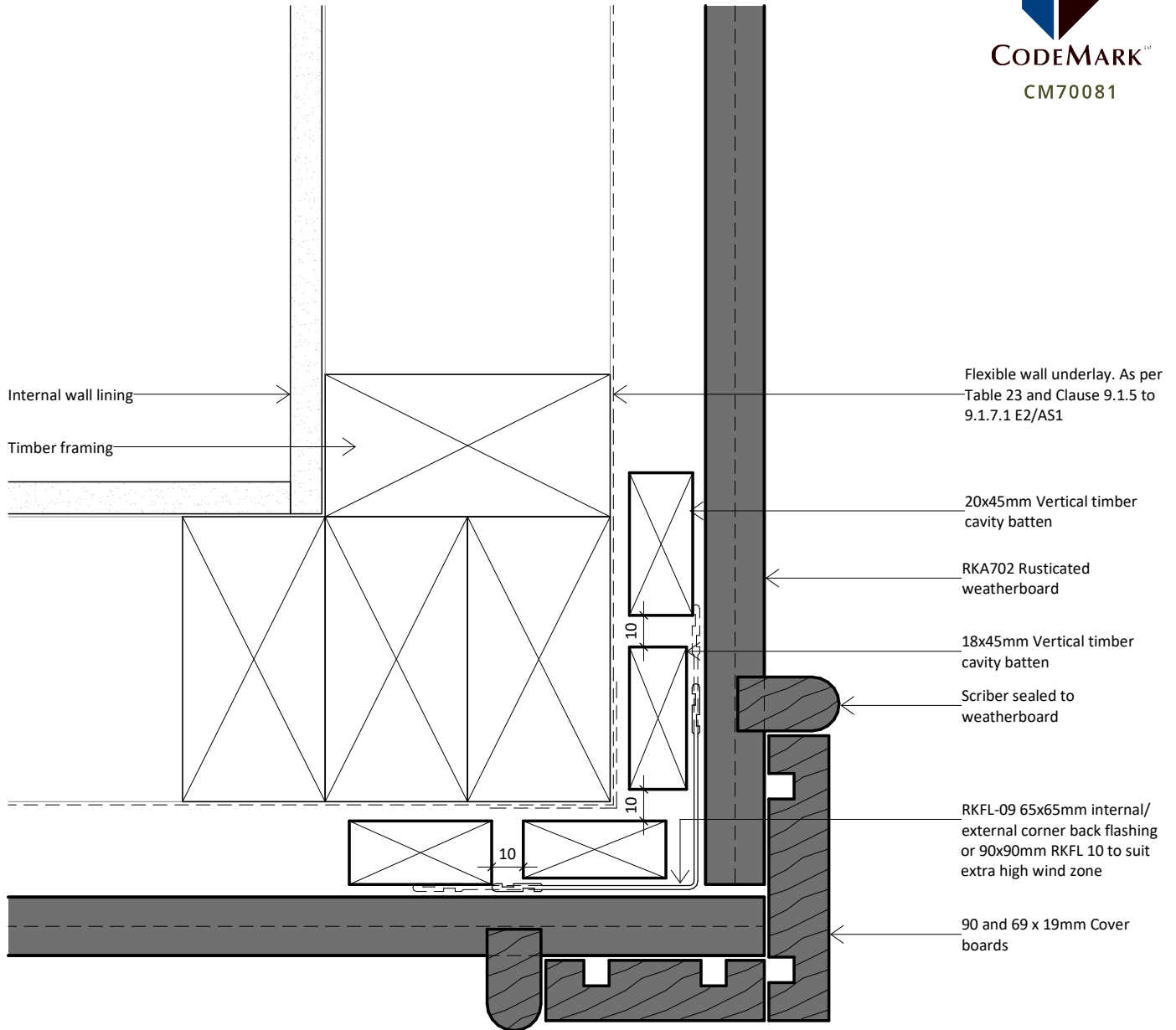

www.rosenfeldkidson.co.nz

Postal address: PO Box 621,
Shortland Street, Auckland 1140

Auckland Branch:
T: +64 9 573 0503
F: +64 9 573 0504
513 Mt Wellington Highway
Mt Wellington, Auckland 1060

Christchurch Branch:
T: +64 3 349 3316
F: +64 3 349 3317
15 Edmonton Road
Hornby, Christchurch 8042

Title **External Corner Detail -
Option 2**

Drawing
RKR-C-22

Scale 1 : 2 @ A4 Date 12.10.2020

1. Scope as per Clauses 1.0 and 9.4 E2/AS1
2. Profiles as per NZS 3617, Branz Bulletin 411 and/or compliance achieved through in-service history, length of service not less than 15 years in all NZ environments B2/VM1 1.1.1 (a)
3. Fixings as per Table 24 E2/AS1
4. Compatibility of materials as per Tables 20-22 E2/AS1
5. Flashing as per Clause 4.0 E2/AS1
6. Rigid and flexible underlay as per Table 23 and Clauses 9.1.5 to 9.1.7 E2/AS1 or proprietary approved alternative
7. All weatherboards to be factory oiled to all faces and weathergrooves prior to installation, ensure maintenance is to manufacturers recommendations
8. The weatherboard system relies on the joinery meeting the requirements of NZS 4211 for the relevant building windzone or wind pressure
9. Timber to NZBC B2 Durability B2.3.1(b), Western Red Cedar, Larch and Truwood®
10. Timber framing to NZS 3604:2011

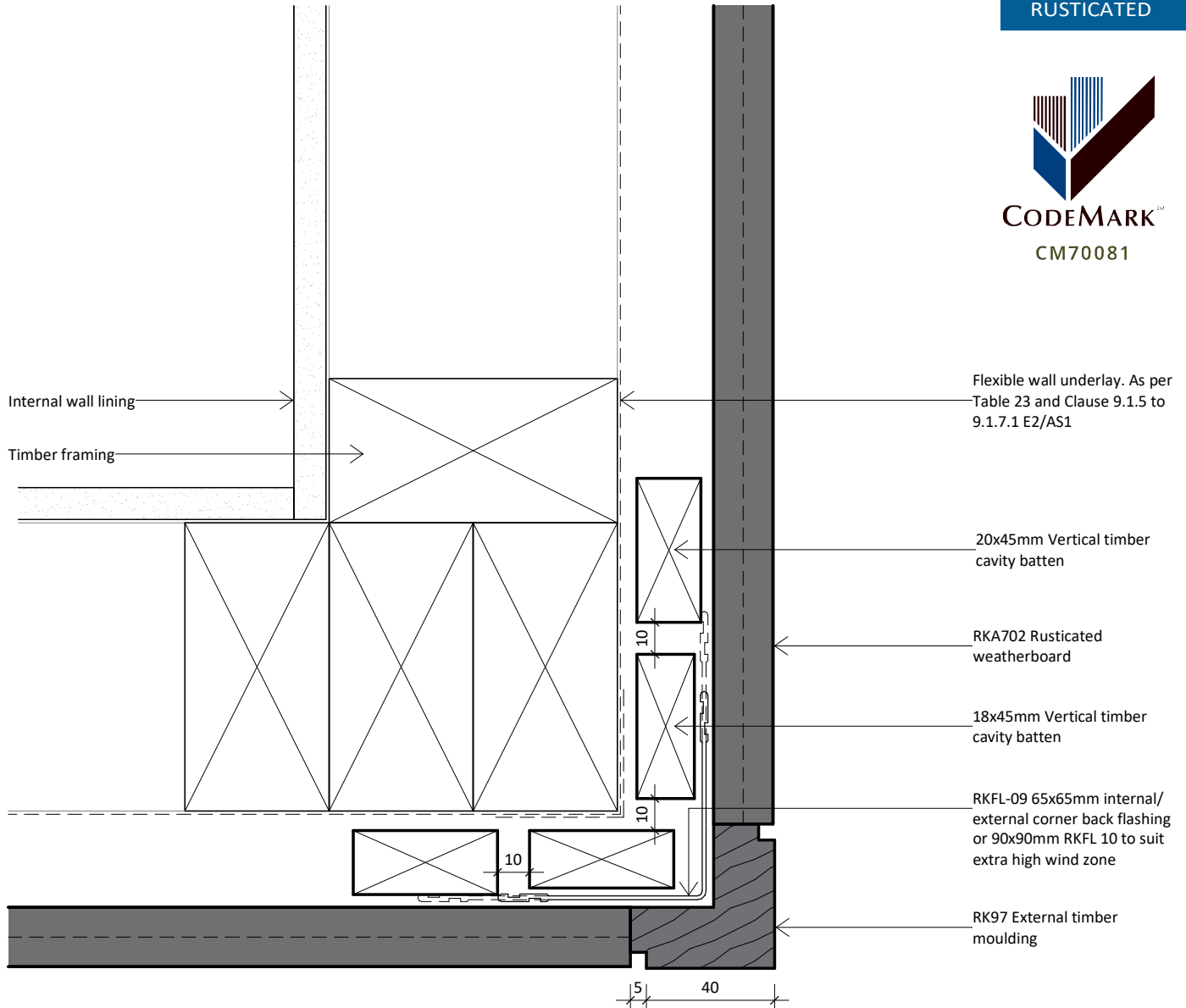

Flexible wall underlay. As per Table 23 and Clause 9.1.5 to 9.1.7.1 E2/AS1

20x45mm Vertical timber cavity batten

RKA702 Rusticated weatherboard

18x45mm Vertical timber cavity batten

RKFL-09 65x65mm internal/external corner back flashing or 90x90mm RKFL 10 to suit extra high wind zone

RK97 External timber moulding

interactive assembly instructions available
<http://wksp.nz/rk-hrw-rkrc23>



get WorkingSpec from Apple App Store or Google Play



www.rosenfeldkidson.co.nz

Postal address: PO Box 621,
Shortland Street, Auckland 1140

Auckland Branch:
 T: +64 9 573 0503
 F: +64 9 573 0504
 513 Mt Wellington Highway
 Mt Wellington, Auckland 1060

Christchurch Branch:
 T: +64 3 349 3316
 F: +64 3 349 3317
 15 Edmonton Road
 Hornby, Christchurch 8042

Title **External Corner RK97
Detail - Option 3**

Drawing **RKR-C-23**

Scale 1 : 2 @ A4 Date 12.10.2020

1. Scope as per Clauses 1.0 and 9.4 E2/AS1
2. Profiles as per NZS 3617, Branz Bulletin 411 and/or compliance achieved through in-service history, length of service not less than 15 years in all NZ environments B2/VM1 1.1.1 (a)
3. Fixings as per Table 24 E2/AS1
4. Compatibility of materials as per Tables 20-22 E2/AS1
5. Flashing as per Clause 4.0 E2/AS1
6. Rigid and flexible underlay as per Table 23 and Clauses 9.1.5 to 9.1.7 E2/AS1 or proprietary approved alternative
7. All weatherboards to be factory oiled to all faces and weathergrooves prior to installation, ensure maintenance is to manufacturers recommendations
8. The weatherboard system relies on the joinery meeting the requirements of NZS 4211 for the relevant building windzone or wind pressure
9. Timber to NZBC B2 Durability B2.3.1(b), Western Red Cedar, Larch and Truwood®
10. Timber framing to NZS 3604:2011

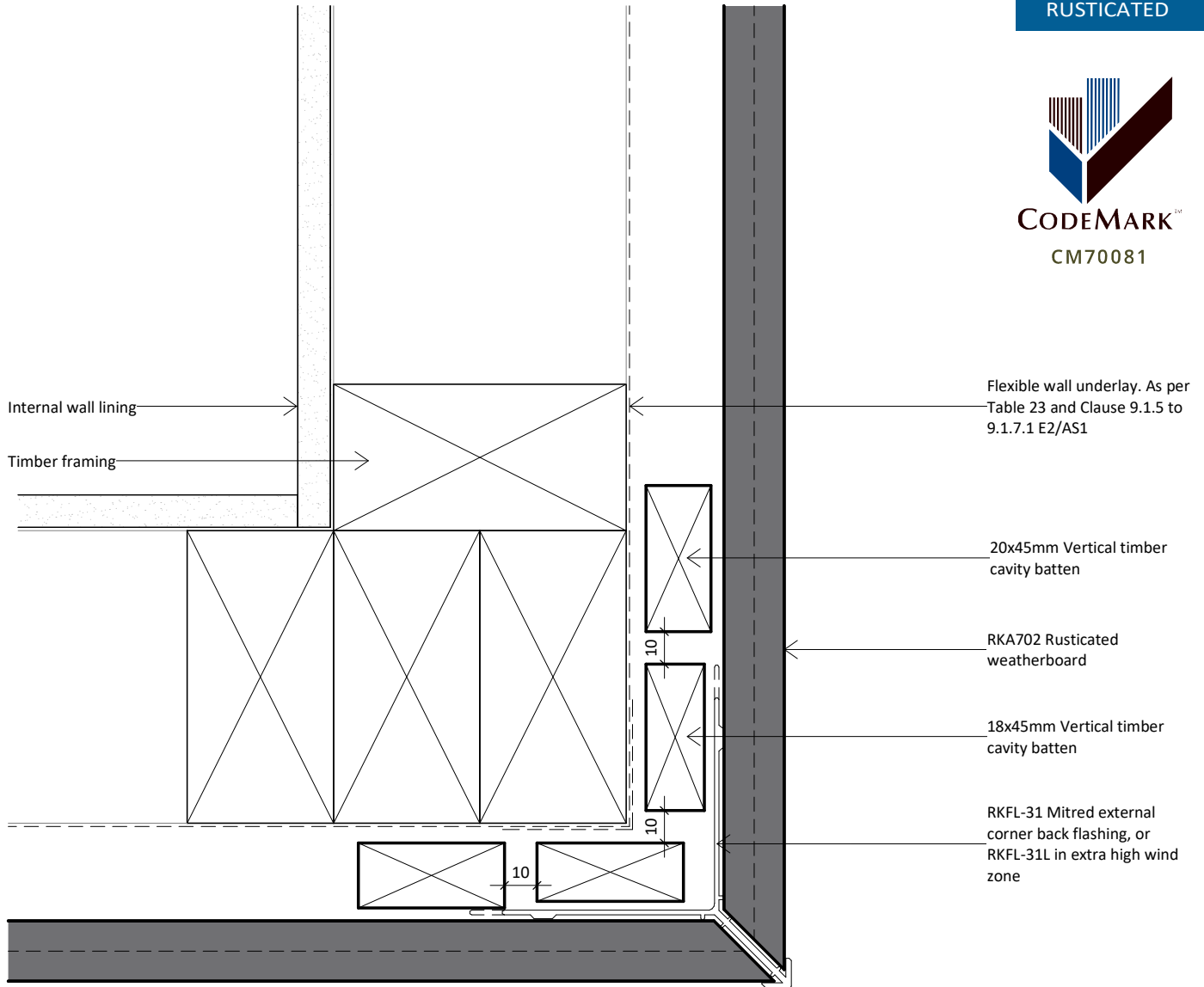

interactive assembly instructions available
<http://wksp.nz/rk-hrw-rkrc25>



get WorkingSpec from Apple App Store or Google Play



www.rosenfeldkidson.co.nz

Postal address: PO Box 621,
Shortland Street, Auckland 1140

Auckland Branch:
 T: +64 9 573 0503
 F: +64 9 573 0504
 513 Mt Wellington Highway
 Mt Wellington, Auckland 1060

Christchurch Branch:
 T: +64 3 349 3316
 F: +64 3 349 3317
 15 Edmonton Road
 Hornby, Christchurch 8042

Title **External Corner Detail - Option 5**

Drawing **RKR-C-25**

Scale 1 : 2 @ A4 Date 12.10.2020

1. Scope as per Clauses 1.0 and 9.4 E2/AS1
2. Profiles as per NZS 3617, Branz Bulletin 411 and/or compliance achieved through in-service history, length of service not less than 15 years in all NZ environments B2/VM1 1.1.1 (a)
3. Fixings as per Table 24 E2/AS1
4. Compatibility of materials as per Tables 20-22 E2/AS1
5. Flashing as per Clause 4.0 E2/AS1
6. Rigid and flexible underlay as per Table 23 and Clauses 9.1.5 to 9.1.7 E2/AS1 or proprietary approved alternative
7. All weatherboards to be factory oiled to all faces and weathergrooves prior to installation, ensure maintenance is to manufacturers recommendations
8. The weatherboard system relies on the joinery meeting the requirements of NZS 4211 for the relevant building windzone or wind pressure
9. Timber to NZBC B2 Durability B2.3.1(b), Western Red Cedar, Larch and Truwood®
10. Timber framing to NZS 3604:2011

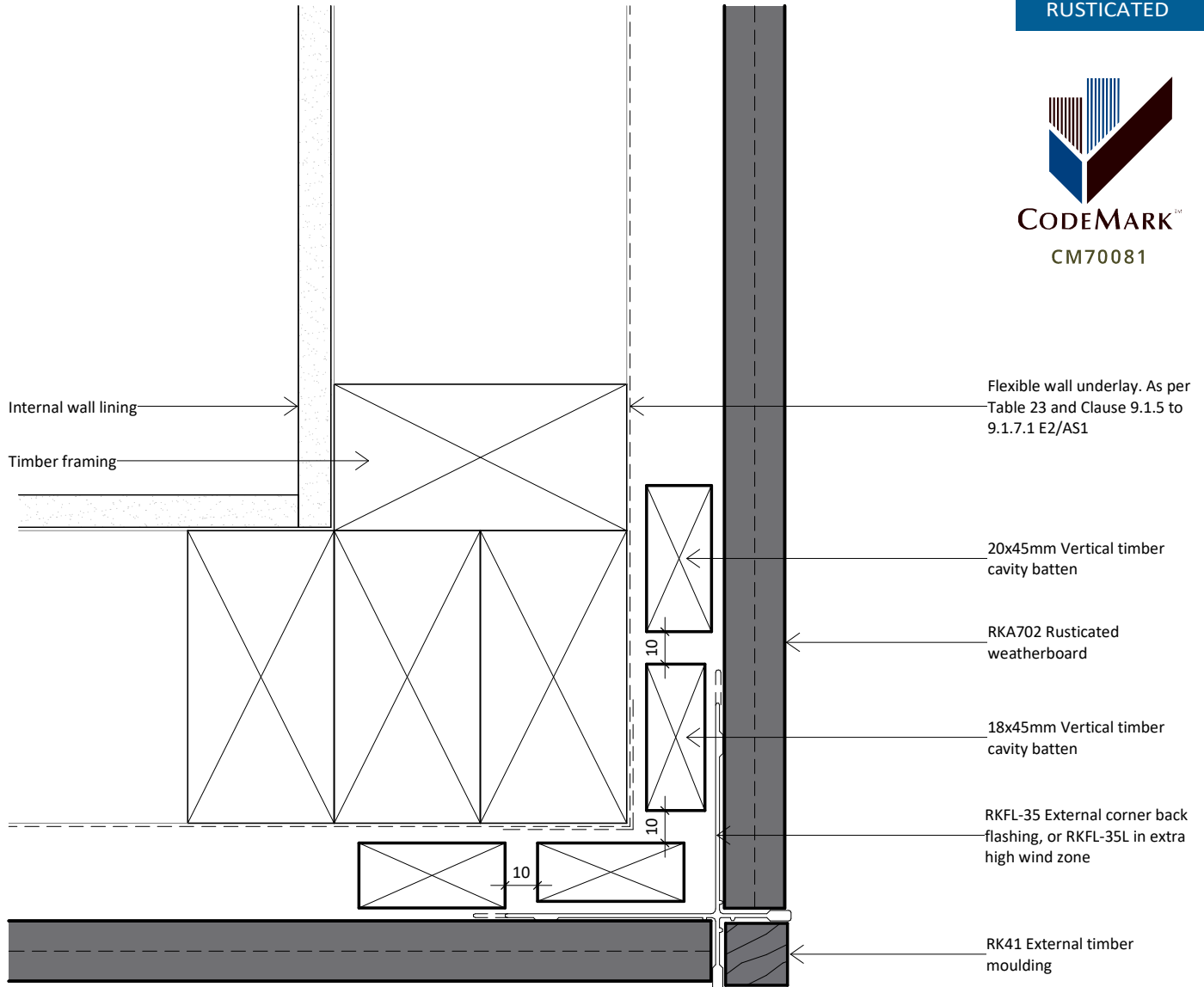

interactive assembly instructions available
<http://wksp.nz/rk-hrw-rkrc26>



get WorkingSpec from Apple App Store or Google Play



www.rosenfeldkidson.co.nz

Postal address: PO Box 621,
Shortland Street, Auckland 1140

Auckland Branch:
 T: +64 9 573 0503
 F: +64 9 573 0504
 513 Mt Wellington Highway
 Mt Wellington, Auckland 1060

Christchurch Branch:
 T: +64 3 349 3316
 F: +64 3 349 3317
 15 Edmonton Road
 Hornby, Christchurch 8042

Title **External Corner Detail - Option 6**

Drawing **RKR-C-26**

Scale 1 : 2 @ A4 Date 12.10.2020

1. Scope as per Clauses 1.0 and 9.4 E2/AS1
2. Profiles as per NZS 3617, Branz Bulletin 411 and/or compliance achieved through in-service history, length of service not less than 15 years in all NZ environments B2/VM1 1.1.1 (a)
3. Fixings as per Table 24 E2/AS1
4. Compatibility of materials as per Tables 20-22 E2/AS1
5. Flashing as per Clause 4.0 E2/AS1
6. Rigid and flexible underlay as per Table 23 and Clauses 9.1.5 to 9.1.7 E2/AS1 or proprietary approved alternative
7. All weatherboards to be factory oiled to all faces and weathergrooves prior to installation, ensure maintenance is to manufacturers recommendations
8. The weatherboard system relies on the joinery meeting the requirements of NZS 4211 for the relevant building windzone or wind pressure
9. Timber to NZBC B2 Durability B2.3.1(b), Western Red Cedar, Larch and Truwood®
10. Timber framing to NZS 3604:2011

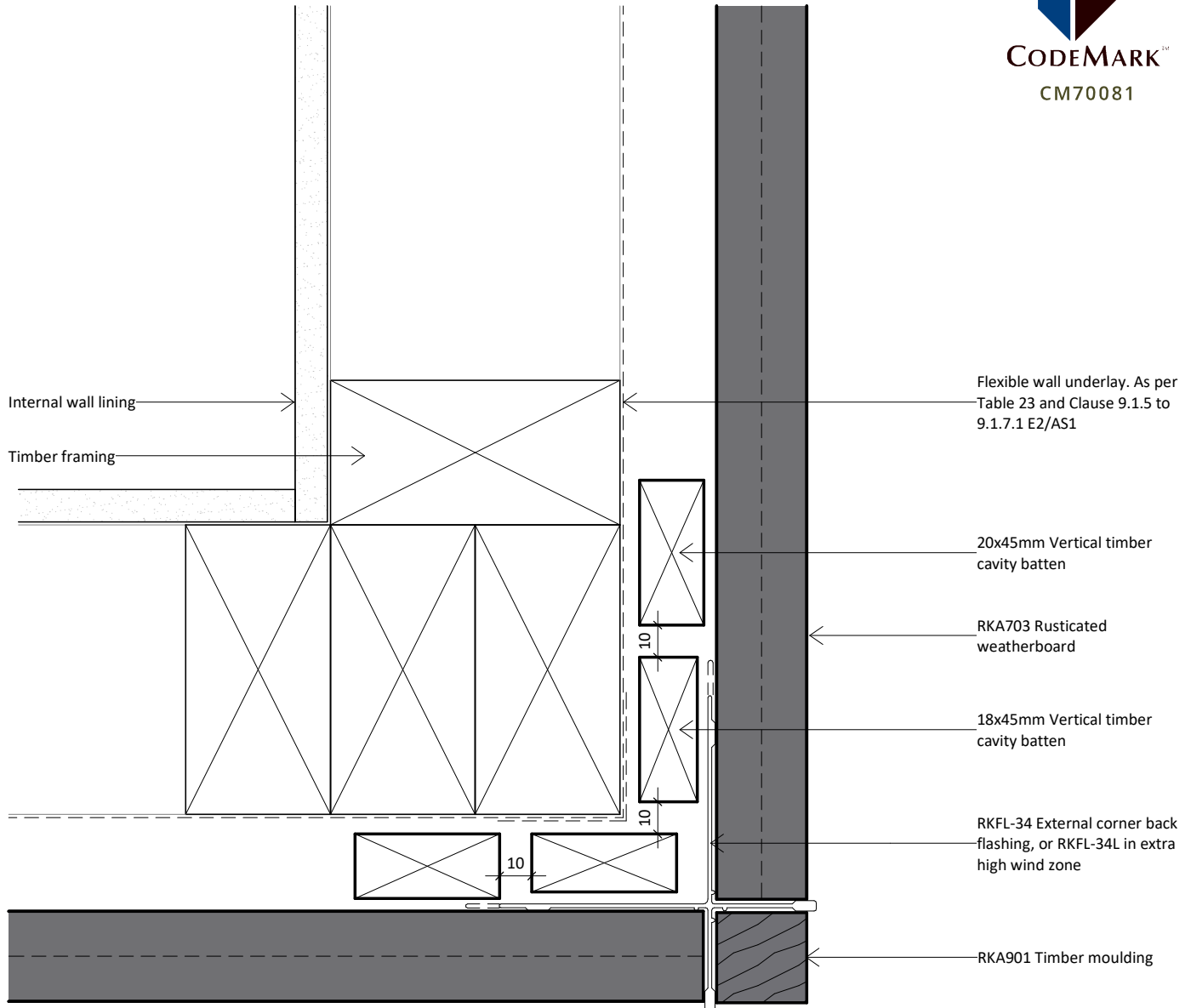

www.rosenfeldkidson.co.nz

Postal address: PO Box 621,
Shortland Street, Auckland 1140

Auckland Branch:
T: +64 9 573 0503
F: +64 9 573 0504
513 Mt Wellington Highway
Mt Wellington, Auckland 1060

Christchurch Branch:
T: +64 3 349 3316
F: +64 3 349 3317
15 Edmonton Road
Hornby, Christchurch 8042

Title **External Corner Detail -
Option 7**

Drawing
RKR-C-27

Scale 1 : 2 @ A4 Date 12.10.2020

1. Scope as per Clauses 1.0 and 9.4 E2/AS1
2. Profiles as per NZS 3617, Branz Bulletin 411 and/or compliance achieved through in-service history, length of service not less than 15 years in all NZ environments B2/VM1 1.1.1 (a)
3. Fixings as per Table 24 E2/AS1
4. Compatibility of materials as per Tables 20-22 E2/AS1
5. Flashing as per Clause 4.0 E2/AS1
6. Rigid and flexible underlay as per Table 23 and Clauses 9.1.5 to 9.1.7 E2/AS1 or proprietary approved alternative
7. All weatherboards to be factory oiled to all faces and weathergrooves prior to installation, ensure maintenance is to manufacturers recommendations
8. The weatherboard system relies on the joinery meeting the requirements of NZS 4211 for the relevant building windzone or wind pressure
9. Timber to NZBC B2 Durability B2.3.1(b), Western Red Cedar, Larch and Truwood®
10. Timber framing to NZS 3604:2011

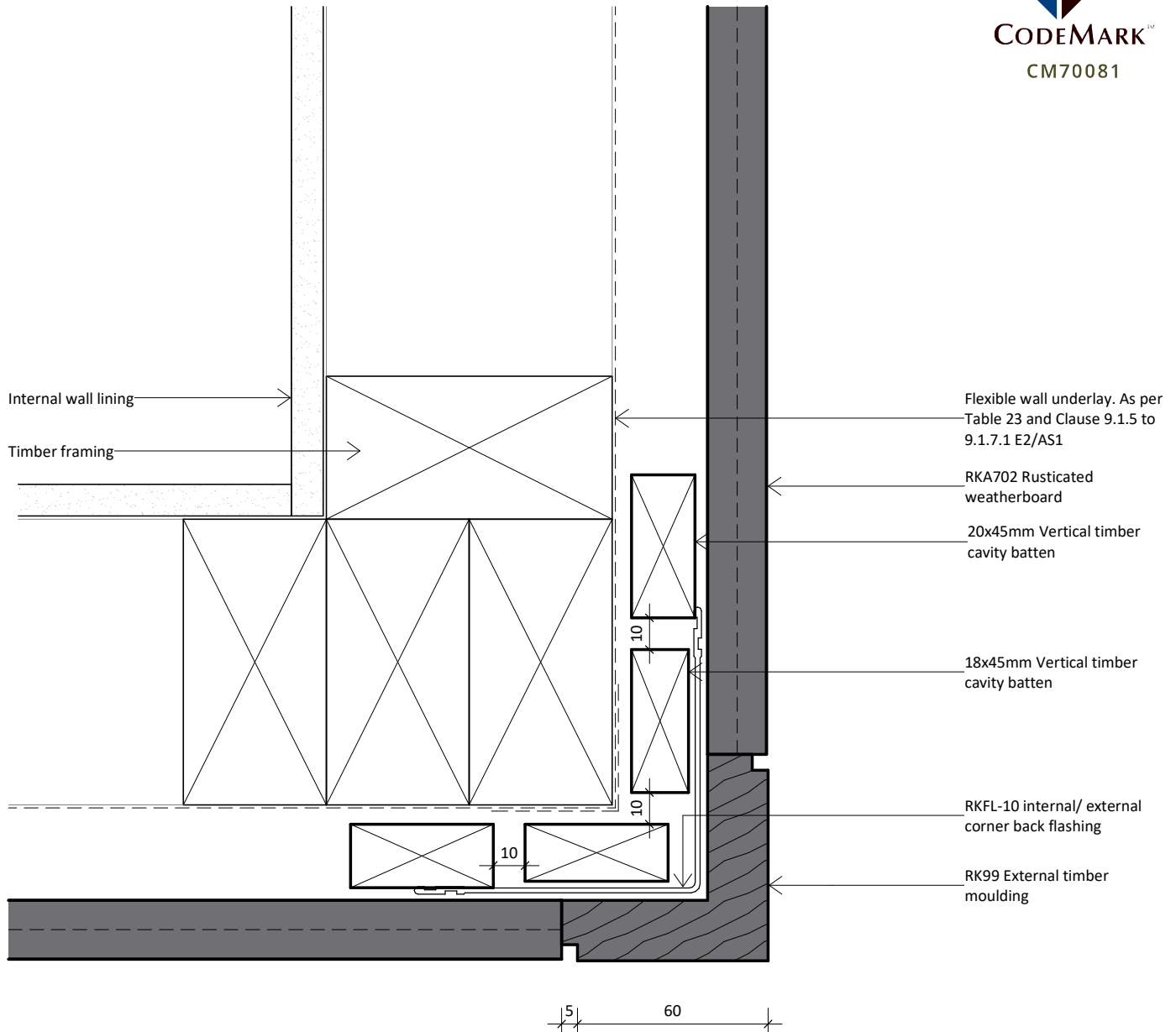

www.rosenfeldkidson.co.nz

Postal address: PO Box 621,
Shortland Street, Auckland 1140

Auckland Branch:
T: +64 9 573 0503
F: +64 9 573 0504
513 Mt Wellington Highway
Mt Wellington, Auckland 1060

Christchurch Branch:
T: +64 3 349 3316
F: +64 3 349 3317
15 Edmonton Road
Hornby, Christchurch 8042

Title **External Corner Detail -
Option 8**

Drawing
RKR-C-28

Scale 1 : 2 @ A4 Date 12.10.2020

1. Scope as per Clauses 1.0 and 9.4 E2/AS1
2. Profiles as per NZS 3617, Branz Bulletin 411 and/or compliance achieved through in-service history, length of service not less than 15 years in all NZ environments B2/VM1 1.1.1 (a)
3. Fixings as per Table 24 E2/AS1
4. Compatibility of materials as per Tables 20-22 E2/AS1
5. Flashing as per Clause 4.0 E2/AS1
6. Rigid and flexible underlay as per Table 23 and Clauses 9.1.5 to 9.1.7 E2/AS1 or proprietary approved alternative
7. All weatherboards to be factory oiled to all faces and weathergrooves prior to installation, ensure maintenance is to manufacturers recommendations
8. The weatherboard system relies on the joinery meeting the requirements of NZS 4211 for the relevant building windzone or wind pressure
9. Timber to NZBC B2 Durability B2.3.1(b), Western Red Cedar, Larch and Truwood®
10. Timber framing to NZS 3604:2011

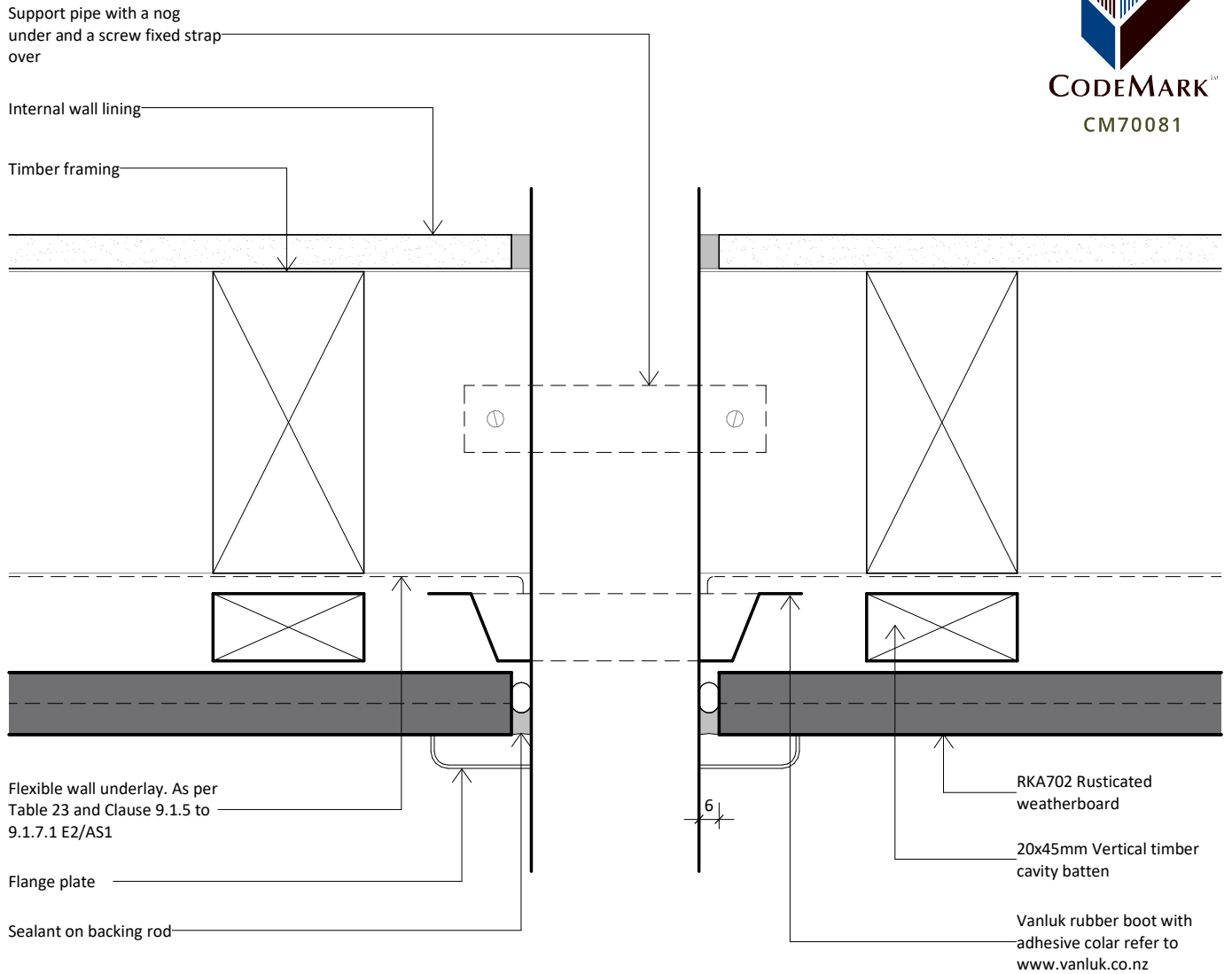

www.rosenfeldkidson.co.nz

Postal address: PO Box 621,
Shortland Street, Auckland 1140

Auckland Branch:
T: +64 9 573 0503
F: +64 9 573 0504
513 Mt Wellington Highway
Mt Wellington, Auckland 1060

Christchurch Branch:
T: +64 3 349 3316
F: +64 3 349 3317
15 Edmonton Road
Hornby, Christchurch 8042

Title **Pipe Penetration Detail**

Drawing

RKR-C-31

Scale 1 : 2 @ A4

Date 12.10.2020

1. Scope as per Clauses 1.0 and 9.4 E2/AS1
2. Profiles as per NZS 3617, Branz Bulletin 411 and/or compliance achieved through in-service history, length of service not less than 15 years in all NZ environments B2/VM1 1.1.1 (a)
3. Fixings as per Table 24 E2/AS1
4. Compatibility of materials as per Tables 20-22 E2/AS1
5. Flashing as per Clause 4.0 E2/AS1
6. Rigid and flexible underlay as per Table 23 and Clauses 9.1.5 to 9.1.7 E2/AS1 or proprietary approved alternative
7. All weatherboards to be factory oiled to all faces and weathergrooves prior to installation, ensure maintenance is to manufacturers recommendations
8. The weatherboard system relies on the joinery meeting the requirements of NZS 4211 for the relevant building windzone or wind pressure
9. Timber to NZBC B2 Durability B2.3.1(b), Western Red Cedar, Larch and Truwood®
10. Timber framing to NZS 3604:2011

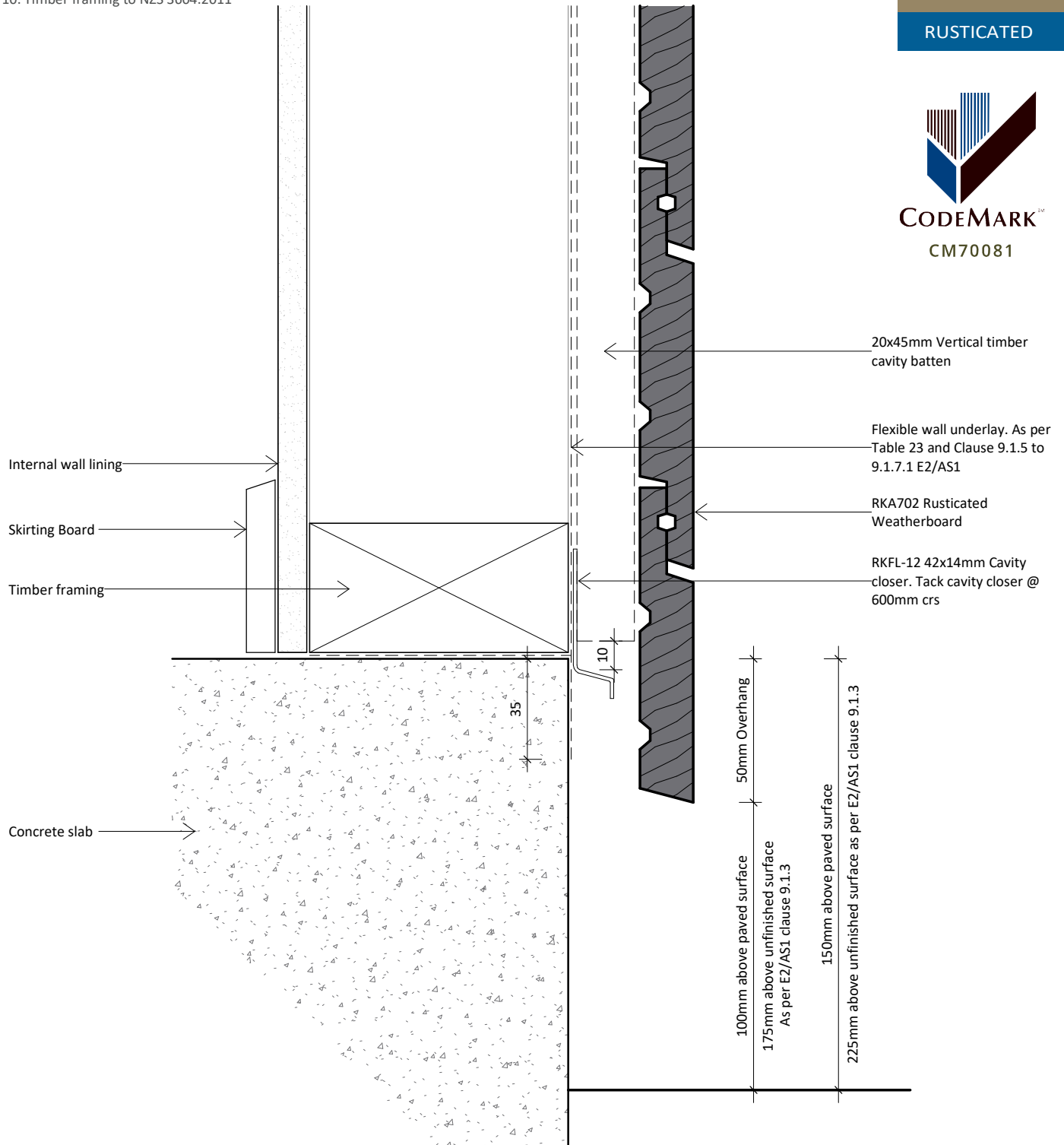

www.rosenfeldkidson.co.nz

Postal address: PO Box 621,
Shortland Street, Auckland 1140

Auckland Branch:
T: +64 9 573 0503
F: +64 9 573 0504
513 Mt Wellington Highway
Mt Wellington, Auckland 1060

Christchurch Branch:
T: +64 3 349 3316
F: +64 3 349 3317
15 Edmonton Road
Hornby, Christchurch 8042

Title **Bottom Plate Detail**

Drawing

RKR-C-41

Scale 1 : 2 @ A4

Date 12.10.2020

1. Scope as per Clauses 1.0 and 9.4 E2/AS1
2. Profiles as per NZS 3617, Branz Bulletin 411 and/or compliance achieved through in-service history, length of service not less than 15 years in all NZ environments B2/VM1 1.1.1 (a)
3. Fixings as per Table 24 E2/AS1
4. Compatibility of materials as per Tables 20-22 E2/AS1
5. Flashing as per Clause 4.0 E2/AS1
6. Rigid and flexible underlay as per Table 23 and Clauses 9.1.5 to 9.1.7 E2/AS1 or proprietary approved alternative
7. All weatherboards to be factory oiled to all faces and weathergrooves prior to installation, ensure maintenance is to manufacturers recommendations
8. The weatherboard system relies on the joinery meeting the requirements of NZS 4211 for the relevant building windzone or wind pressure
9. Timber to NZBC B2 Durability B2.3.1(b), Western Red Cedar, Larch and Truwood®
10. Timber framing to NZS 3604:2011

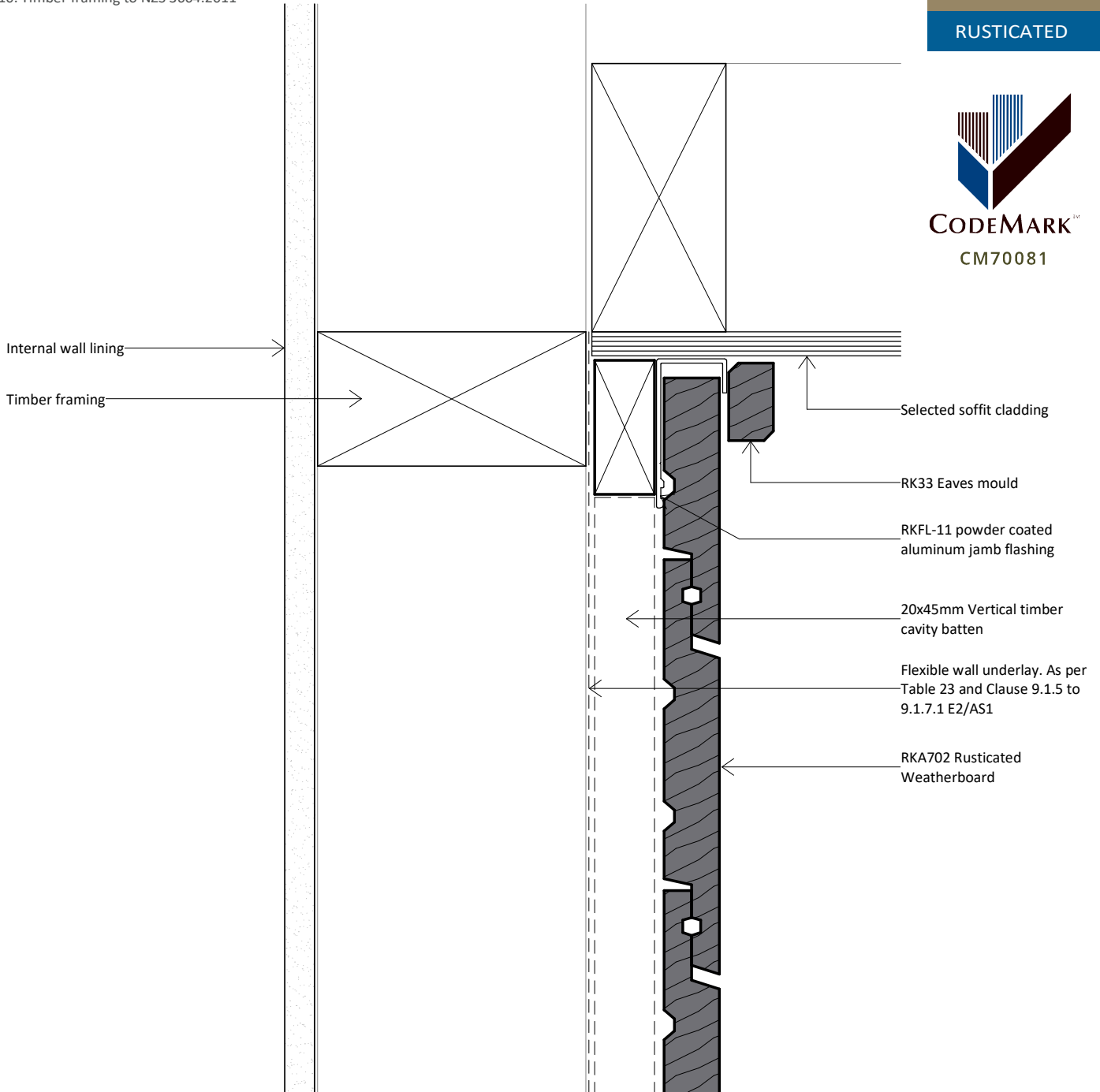

www.rosenfeldkidson.co.nz

Postal address: PO Box 621,
Shortland Street, Auckland 1140

Auckland Branch:
T: +64 9 573 0503
F: +64 9 573 0504
513 Mt Wellington Highway
Mt Wellington, Auckland 1060

Christchurch Branch:
T: +64 3 349 3316
F: +64 3 349 3317
15 Edmonton Road
Hornby, Christchurch 8042

Title **Top Plate to Soffit Detail**

Drawing
RKR-C-42

Scale 1 : 2 @ A4 Date 12.10.2020

1. Scope as per Clauses 1.0 and 9.4 E2/AS1
2. Profiles as per NZS 3617, Branz Bulletin 411 and/or compliance achieved through in-service history, length of service not less than 15 years in all NZ environments B2/VM1 1.1.1 (a)
3. Fixings as per Table 24 E2/AS1
4. Compatibility of materials as per Tables 20-22 E2/AS1
5. Flashing as per Clause 4.0 E2/AS1
6. Rigid and flexible underlay as per Table 23 and Clauses 9.1.5 to 9.1.7 E2/AS1 or proprietary approved alternative
7. All weatherboards to be factory oiled to all faces and weathergrooves prior to installation, ensure maintenance is to manufacturers recommendations
8. The weatherboard system relies on the joinery meeting the requirements of NZS 4211 for the relevant building windzone or wind pressure
9. Timber to NZBC B2 Durability B2.3.1(b), Western Red Cedar, Larch and Truwood®
10. Timber framing to NZS 3604:2011

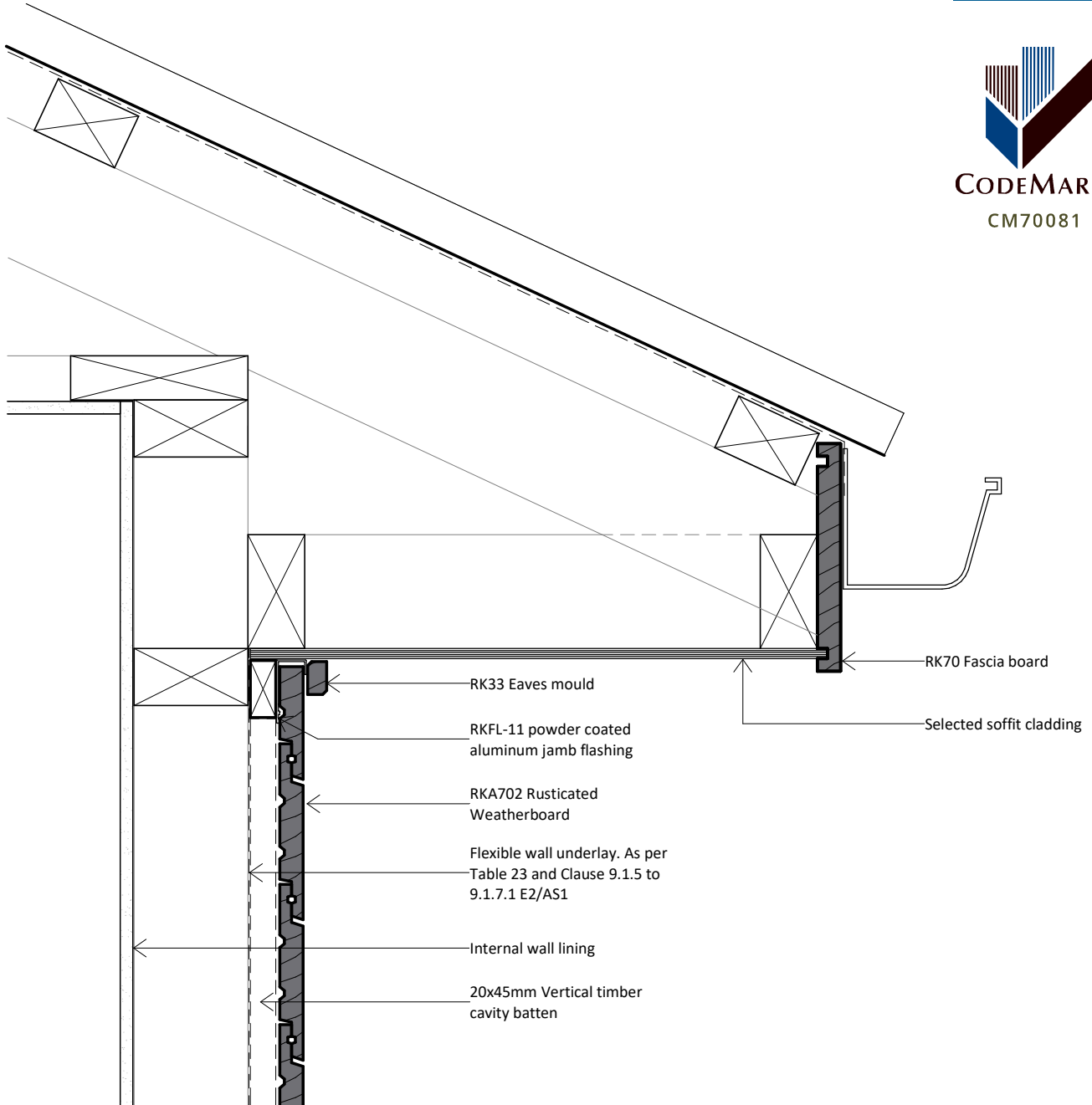

www.rosenfeldkidson.co.nz

Postal address: PO Box 621,
Shortland Street, Auckland 1140

Auckland Branch:
 T: +64 9 573 0503
 F: +64 9 573 0504
 513 Mt Wellington Highway
 Mt Wellington, Auckland 1060

Christchurch Branch:
 T: +64 3 349 3316
 F: +64 3 349 3317
 15 Edmonton Road
 Hornby, Christchurch 8042

Title **Barge Detail**

Drawing
RKR-C-43

Scale 1 : 5 @ A4 Date 12.10.2020

1. Scope as per Clauses 1.0 and 9.4 E2/AS1
2. Profiles as per NZS 3617, Branz Bulletin 411 and/or compliance achieved through in-service history, length of service not less than 15 years in all NZ environments B2/VM1 1.1.1 (a)
3. Fixings as per Table 24 E2/AS1
4. Compatibility of materials as per Tables 20-22 E2/AS1
5. Flashing as per Clause 4.0 E2/AS1
6. Rigid and flexible underlay as per Table 23 and Clauses 9.1.5 to 9.1.7 E2/AS1 or proprietary approved alternative
7. All weatherboards to be factory oiled to all faces and weathergrooves prior to installation, ensure maintenance is to manufacturers recommendations
8. The weatherboard system relies on the joinery meeting the requirements of NZS 4211 for the relevant building windzone or wind pressure
9. Timber to NZBC B2 Durability B2.3.1(b), Western Red Cedar, Larch and Truwood®
10. Timber framing to NZS 3604:2011

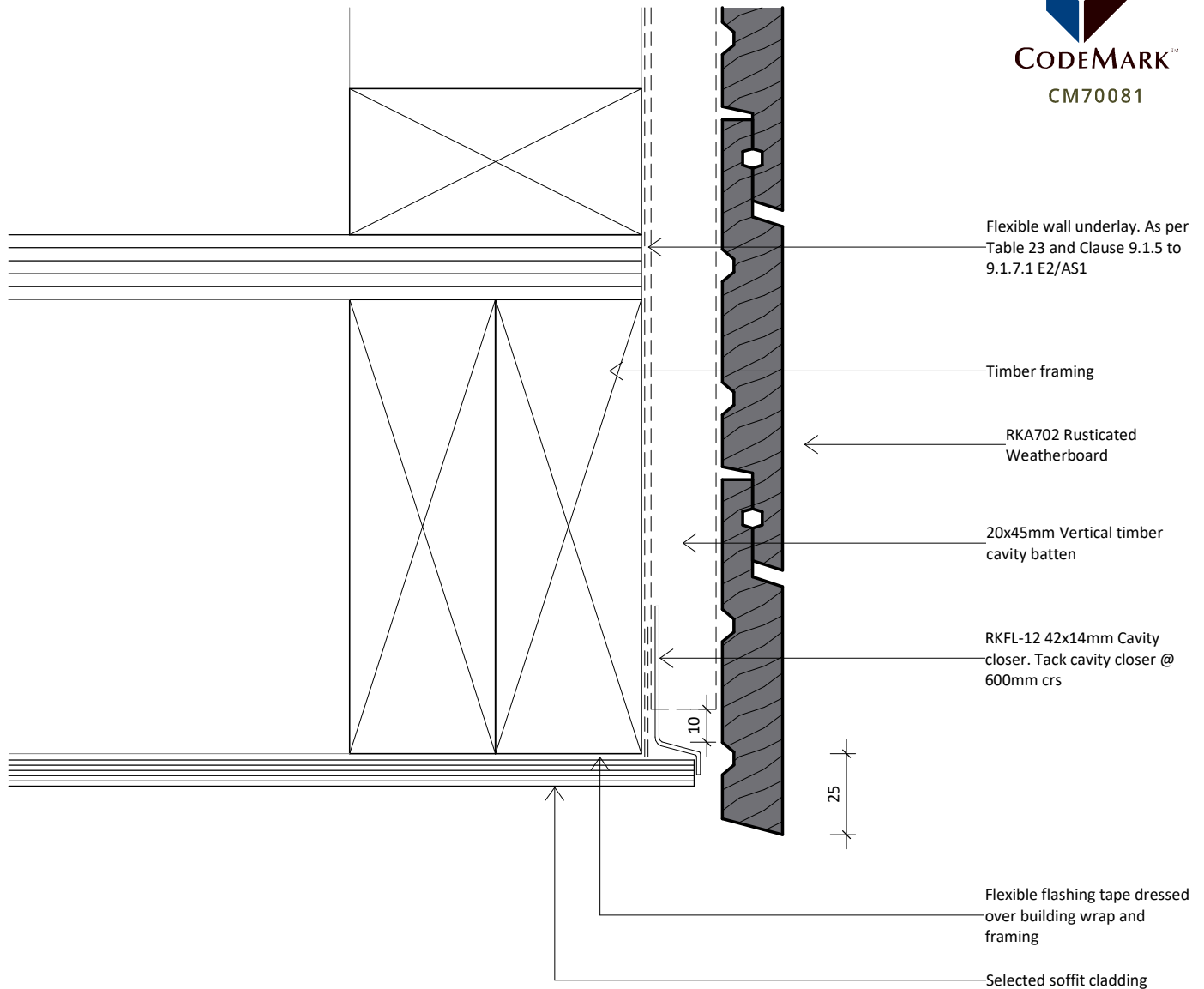

www.rosenfeldkidson.co.nz

Postal address: PO Box 621,
Shortland Street, Auckland 1140

Auckland Branch:
T: +64 9 573 0503
F: +64 9 573 0504
513 Mt Wellington Highway
Mt Wellington, Auckland 1060

Christchurch Branch:
T: +64 3 349 3316
F: +64 3 349 3317
15 Edmonton Road
Hornby, Christchurch 8042

Title **Soffit Detail**

Drawing

RKR-C-44

Scale 1 : 2 @ A4 Date 12.10.2020

1. Scope as per Clauses 1.0 and 9.4 E2/AS1
2. Profiles as per NZS 3617, Branz Bulletin 411 and/or compliance achieved through in-service history, length of service not less than 15 years in all NZ environments B2/VM1 1.1.1 (a)
3. Fixings as per Table 24 E2/AS1
4. Compatibility of materials as per Tables 20-22 E2/AS1
5. Flashing as per Clause 4.0 E2/AS1
6. Rigid and flexible underlay as per Table 23 and Clauses 9.1.5 to 9.1.7 E2/AS1 or proprietary approved alternative
7. All weatherboards to be factory oiled to all faces and weathergrooves prior to installation, ensure maintenance is to manufacturers recommendations
8. The weatherboard system relies on the joinery meeting the requirements of NZS 4211 for the relevant building windzone or wind pressure
9. Timber to NZBC B2 Durability B2.3.1(b), Western Red Cedar, Larch and Truwood®
10. Timber framing to NZS 3604:2011

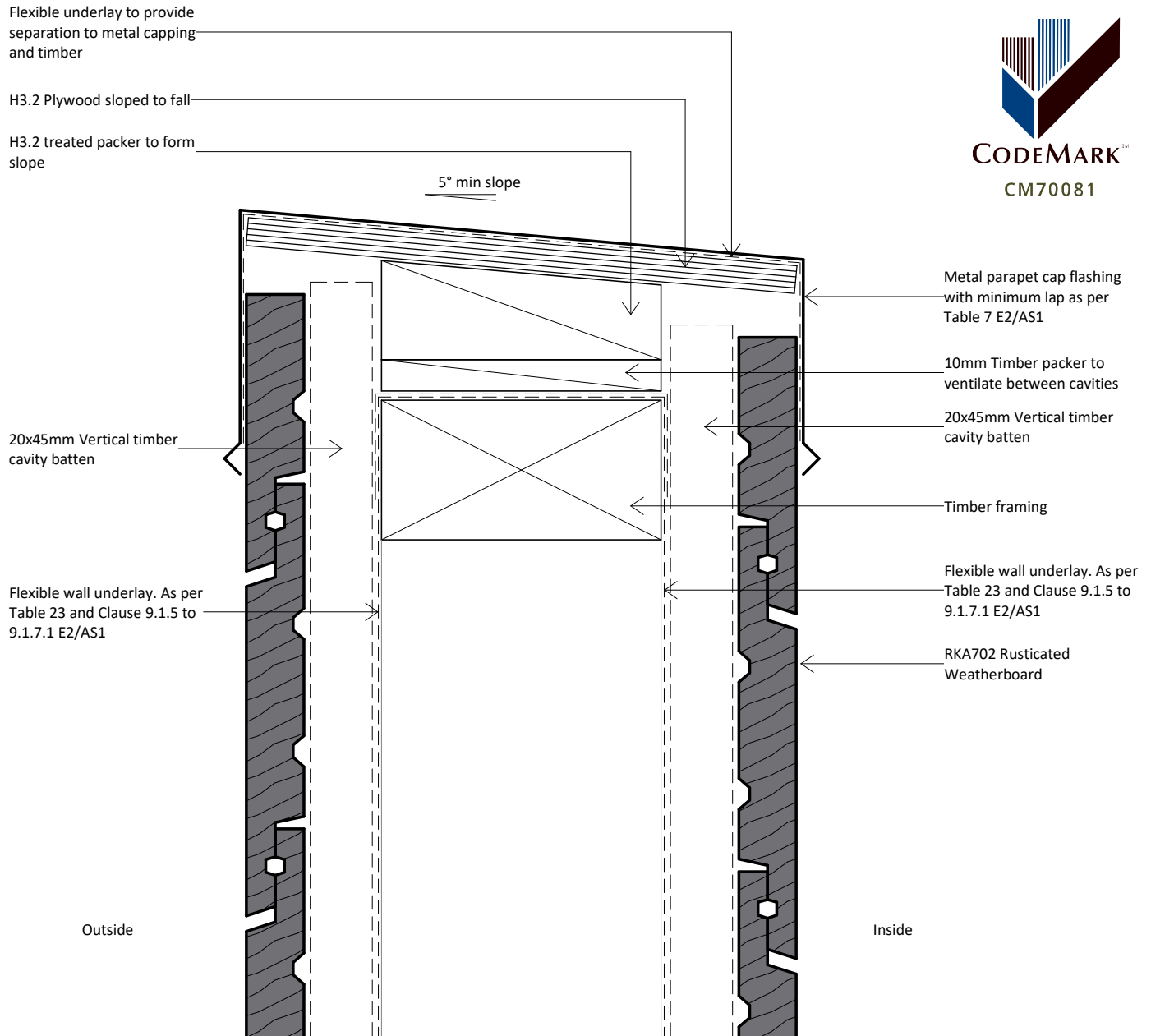

www.rosenfeldkidson.co.nz

Postal address: PO Box 621,
Shortland Street, Auckland 1140

Auckland Branch:
T: +64 9 573 0503
F: +64 9 573 0504
513 Mt Wellington Highway
Mt Wellington, Auckland 1060

Christchurch Branch:
T: +64 3 349 3316
F: +64 3 349 3317
15 Edmonton Road
Hornby, Christchurch 8042

Title **Parapet Detail**

Drawing
RKR-C-45

Scale 1 : 2 @ A4 Date 12.10.2020

1. Scope as per Clauses 1.0 and 9.4 E2/AS1
2. Profiles as per NZS 3617, Branz Bulletin 411 and/or compliance achieved through in-service history, length of service not less than 15 years in all NZ environments B2/VM1 1.1.1 (a)
3. Fixings as per Table 24 E2/AS1
4. Compatibility of materials as per Tables 20-22 E2/AS1
5. Flashing as per Clause 4.0 E2/AS1
6. Rigid and flexible underlay as per Table 23 and Clauses 9.1.5 to 9.1.7 E2/AS1 or proprietary approved alternative
7. All weatherboards to be factory oiled to all faces and weathergrooves prior to installation, ensure maintenance is to manufacturers recommendations
8. The weatherboard system relies on the joinery meeting the requirements of NZS 4211 for the relevant building windzone or wind pressure
9. Timber to NZBC B2 Durability B2.3.1(b), Western Red Cedar, Larch and Truwood®
10. Timber framing to NZS 3604:2011

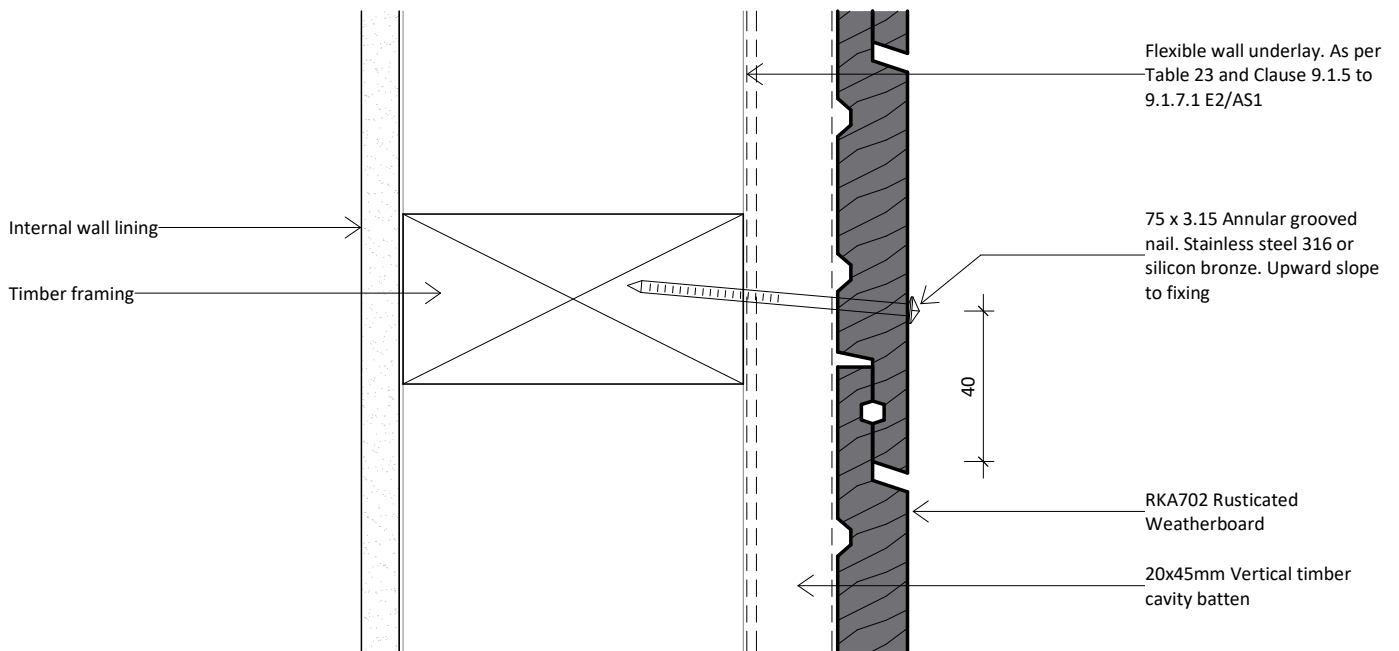
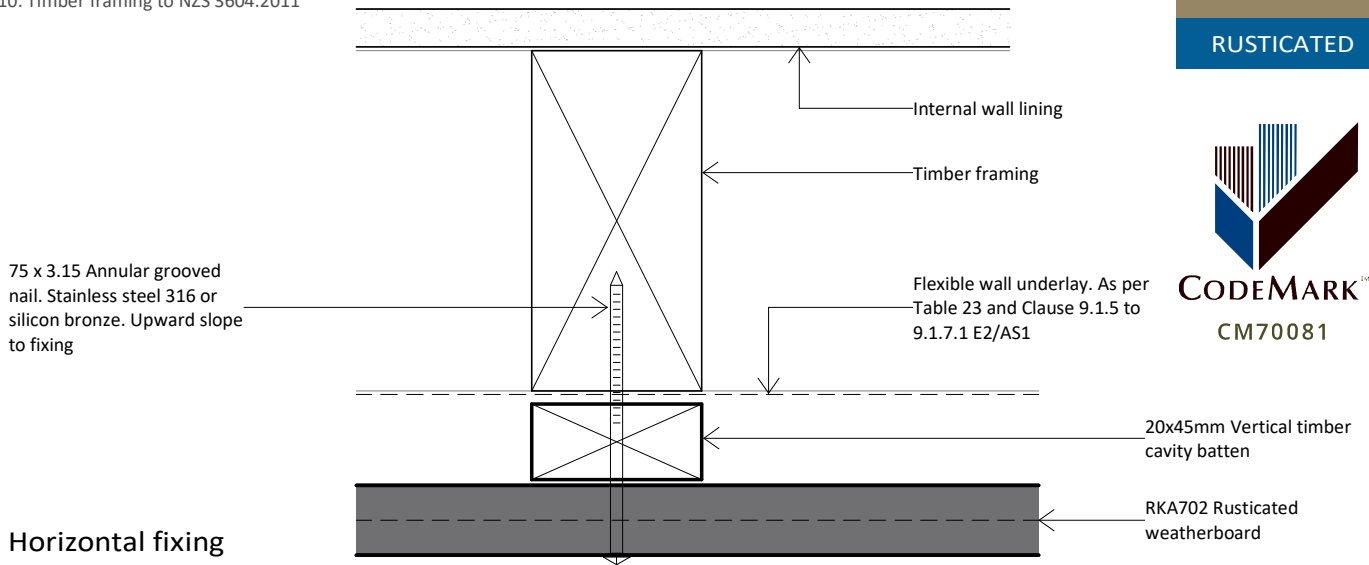

Vertical fixing



www.rosenfeldkidson.co.nz

Postal address: PO Box 621,
Shortland Street, Auckland 1140

Auckland Branch:
T: +64 9 573 0503
F: +64 9 573 0504
513 Mt Wellington Highway
Mt Wellington, Auckland 1060

Christchurch Branch:
T: +64 3 349 3316
F: +64 3 349 3317
15 Edmonton Road
Hornby, Christchurch 8042

Title **Nail Fixing Detail**

Drawing **RKR-C-47**

Scale 1 : 2 @ A4 Date 12.10.2020

1. Scope as per Clauses 1.0 and 9.4 E2/AS1
2. Profiles as per NZS 3617, Branz Bulletin 411 and/or compliance achieved through in-service history, length of service not less than 15 years in all NZ environments B2/VM1 1.1.1 (a)
3. Fixings as per Table 24 E2/AS1
4. Compatibility of materials as per Tables 20-22 E2/AS1
5. Flashing as per Clause 4.0 E2/AS1
6. Rigid and flexible underlay as per Table 23 and Clauses 9.1.5 to 9.1.7 E2/AS1 or proprietary approved alternative
7. All weatherboards to be factory oiled to all faces and weathergrooves prior to installation, ensure maintenance is to manufacturers recommendations
8. The weatherboard system relies on the joinery meeting the requirements of NZS 4211 for the relevant building windzone or wind pressure
9. Timber to NZBC B2 Durability B2.3.1(b), Western Red Cedar, Larch and Truwood®
10. Timber framing to NZS 3604:2011



75 x 3.15 Annular grooved nail. Stainless steel 316. To be countersunk 2mm. Fill countersunk nail head with approved filler. Sand and pre-prime prior to finishing coats.

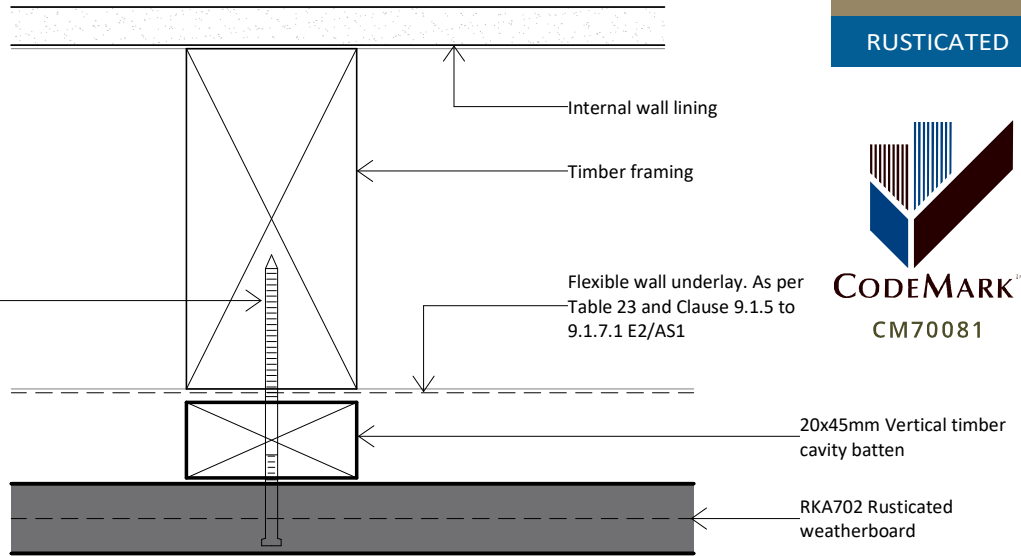

Horizontal fixing

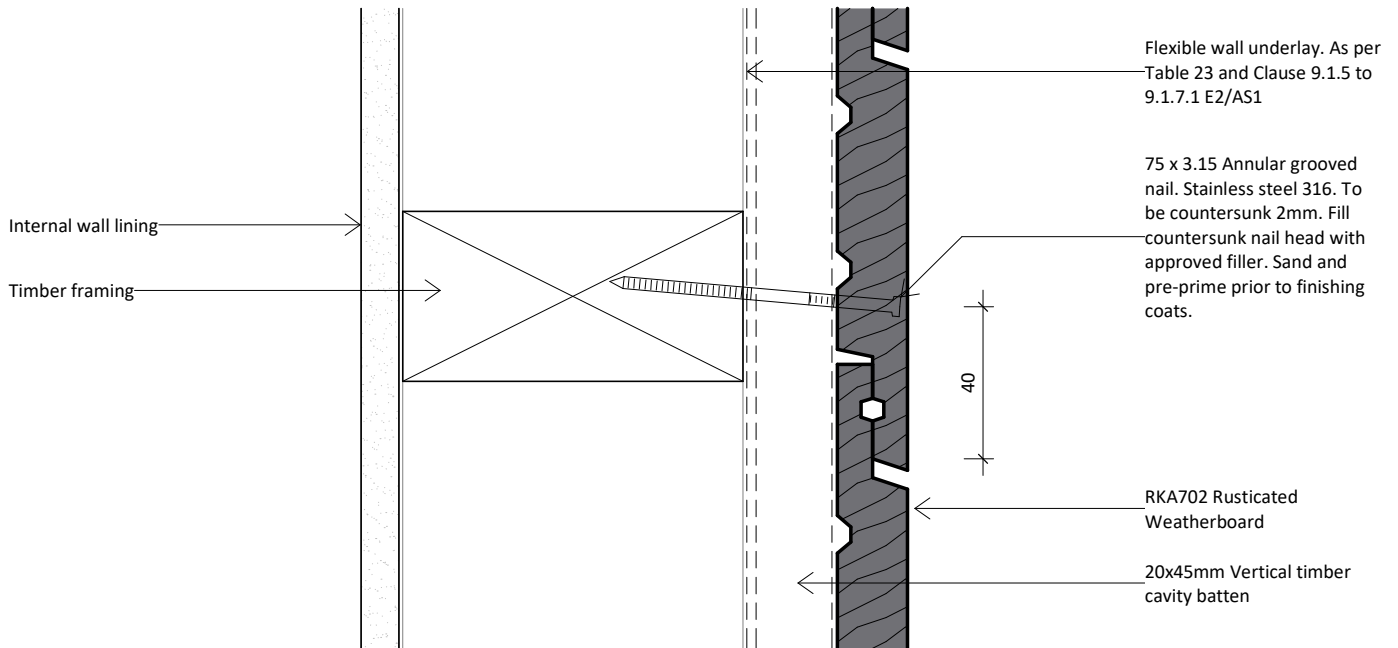

Vertical fixing



www.rosenfeldkidson.co.nz

Postal address: PO Box 621,
Shortland Street, Auckland 1140

Auckland Branch:
T: +64 9 573 0503
F: +64 9 573 0504
513 Mt Wellington Highway
Mt Wellington, Auckland 1060

Christchurch Branch:
T: +64 3 349 3316
F: +64 3 349 3317
15 Edmonton Road
Hornby, Christchurch 8042

Title **Nail Fixing Detail (Paint Finish Only)**

Drawing **RKR-C-49**

Scale 1 : 2 @ A4 Date 12.10.2020

1. Scope as per Clauses 1.0 and 9.4 E2/AS1
2. Profiles as per NZS 3617, Branz Bulletin 411 and/or compliance achieved through in-service history, length of service not less than 15 years in all NZ environments B2/VM1 1.1.1 (a)
3. Fixings as per Table 24 E2/AS1
4. Compatibility of materials as per Tables 20-22 E2/AS1
5. Flashing as per Clause 4.0 E2/AS1
6. Rigid and flexible underlay as per Table 23 and Clauses 9.1.5 to 9.1.7 E2/AS1 or proprietary approved alternative
7. All weatherboards to be factory oiled to all faces and weathergrooves prior to installation, ensure maintenance is to manufacturers recommendations
8. The weatherboard system relies on the joinery meeting the requirements of NZS 4211 for the relevant building windzone or wind pressure
9. Timber to NZBC B2 Durability B2.3.1(b), Western Red Cedar, Larch and Truwood®
10. Timber framing to NZS 3604:2011

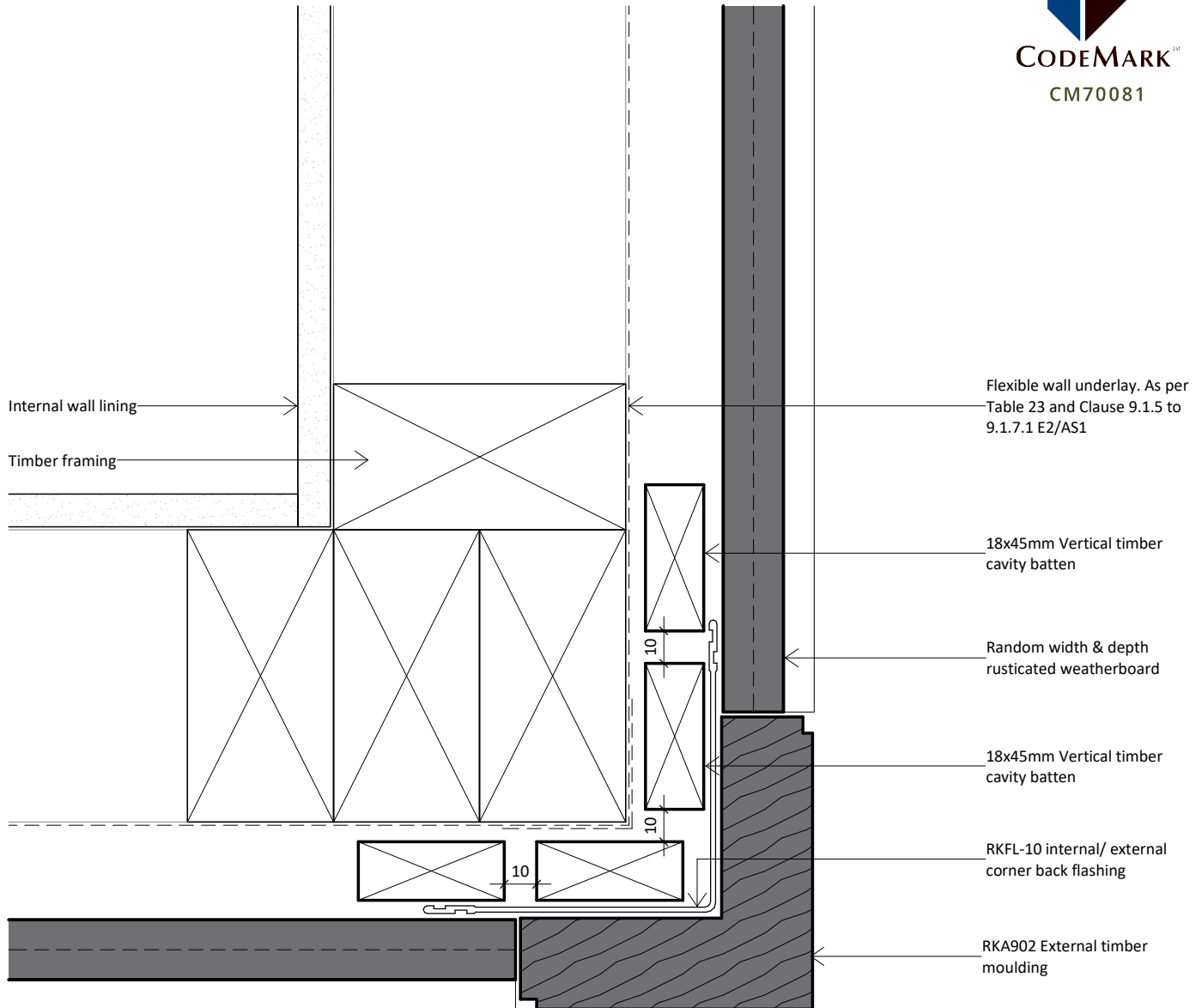

www.rosenfeldkidson.co.nz

Postal address: PO Box 621,
Shortland Street, Auckland 1140

Auckland Branch:
T: +64 9 573 0503
F: +64 9 573 0504
513 Mt Wellington Highway
Mt Wellington, Auckland 1060

Christchurch Branch:
T: +64 3 349 3316
F: +64 3 349 3317
15 Edmonton Road
Hornby, Christchurch 8042

Title **Random W+D External
Corner Detail - Option**

Drawing
RKR-C-94

Scale 1 : 2 @ A4 Date 12.10.2020

1. Scope as per Clauses 1.0 and 9.4 E2/AS1
2. Profiles as per NZS 3617, Branz Bulletin 411 and/or compliance achieved through in-service history, length of service not less than 15 years in all NZ environments B2/VM1 1.1.1 (a)
3. Fixings as per Table 24 E2/AS1
4. Compatibility of materials as per Tables 20-22 E2/AS1
5. Flashing as per Clause 4.0 E2/AS1
6. Rigid and flexible underlay as per Table 23 and Clauses 9.1.5 to 9.1.7 E2/AS1 or proprietary approved alternative
7. All weatherboards to be factory oiled to all faces and weathergrooves prior to installation, ensure maintenance is to manufacturers recommendations
8. The weatherboard system relies on the joinery meeting the requirements of NZS 4211 for the relevant building windzone or wind pressure
9. Timber to NZBC B2 Durability B2.3.1(b), Western Red Cedar, Larch and Truwood®
10. Timber framing to NZS 3604:2011

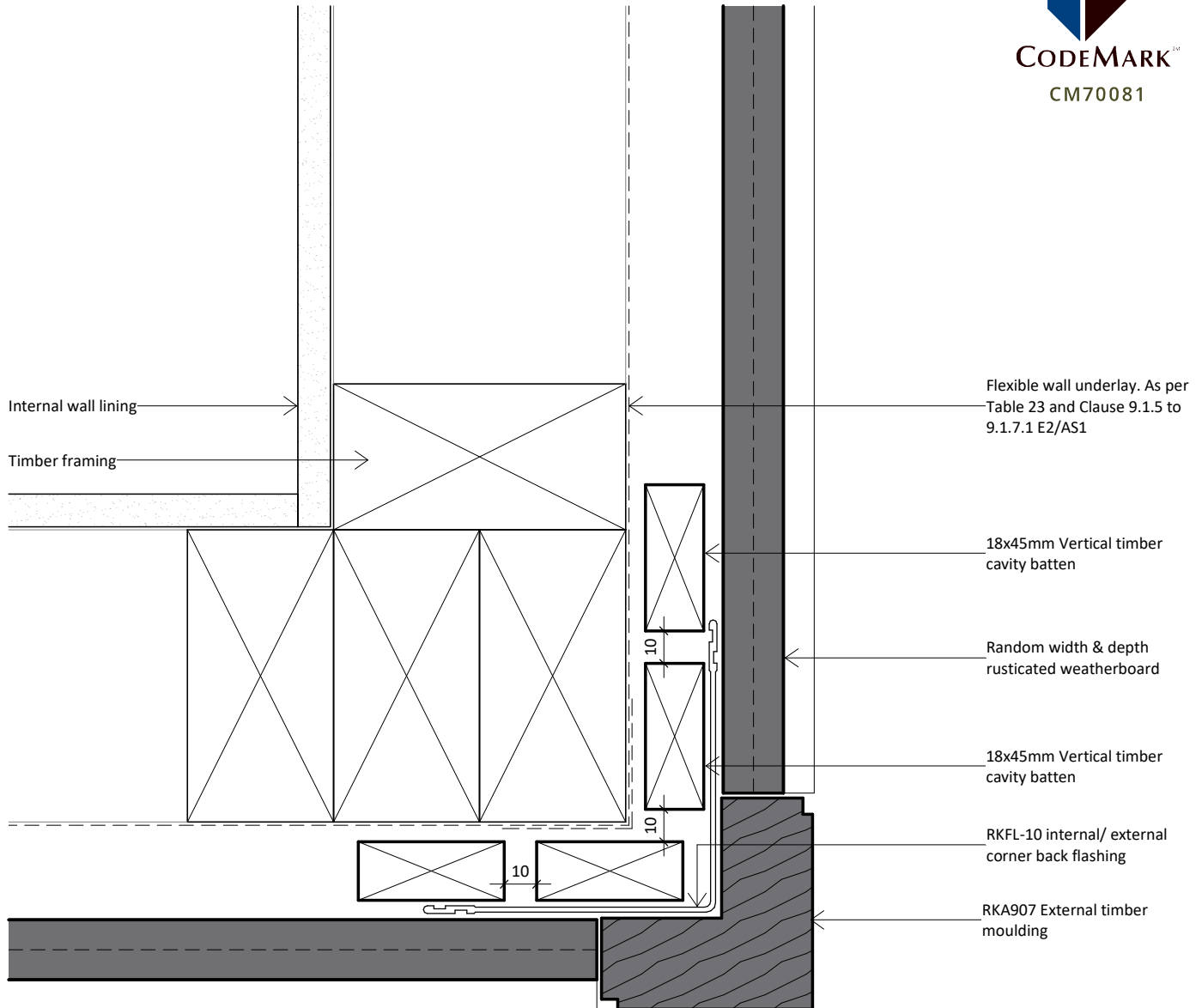

www.rosenfeldkidson.co.nz

Postal address: PO Box 621,
Shortland Street, Auckland 1140

Auckland Branch:
 T: +64 9 573 0503
 F: +64 9 573 0504
 513 Mt Wellington Highway
 Mt Wellington, Auckland 1060

Christchurch Branch:
 T: +64 3 349 3316
 F: +64 3 349 3317
 15 Edmonton Road
 Hornby, Christchurch 8042

Title **Random W+D External
Corner Detail - Option**

Drawing
RKR-C-95

Scale 1 : 2 @ A4 Date 12.10.2020